

SATEL-EASy+ (RS232/422/485)

Configuration setup:

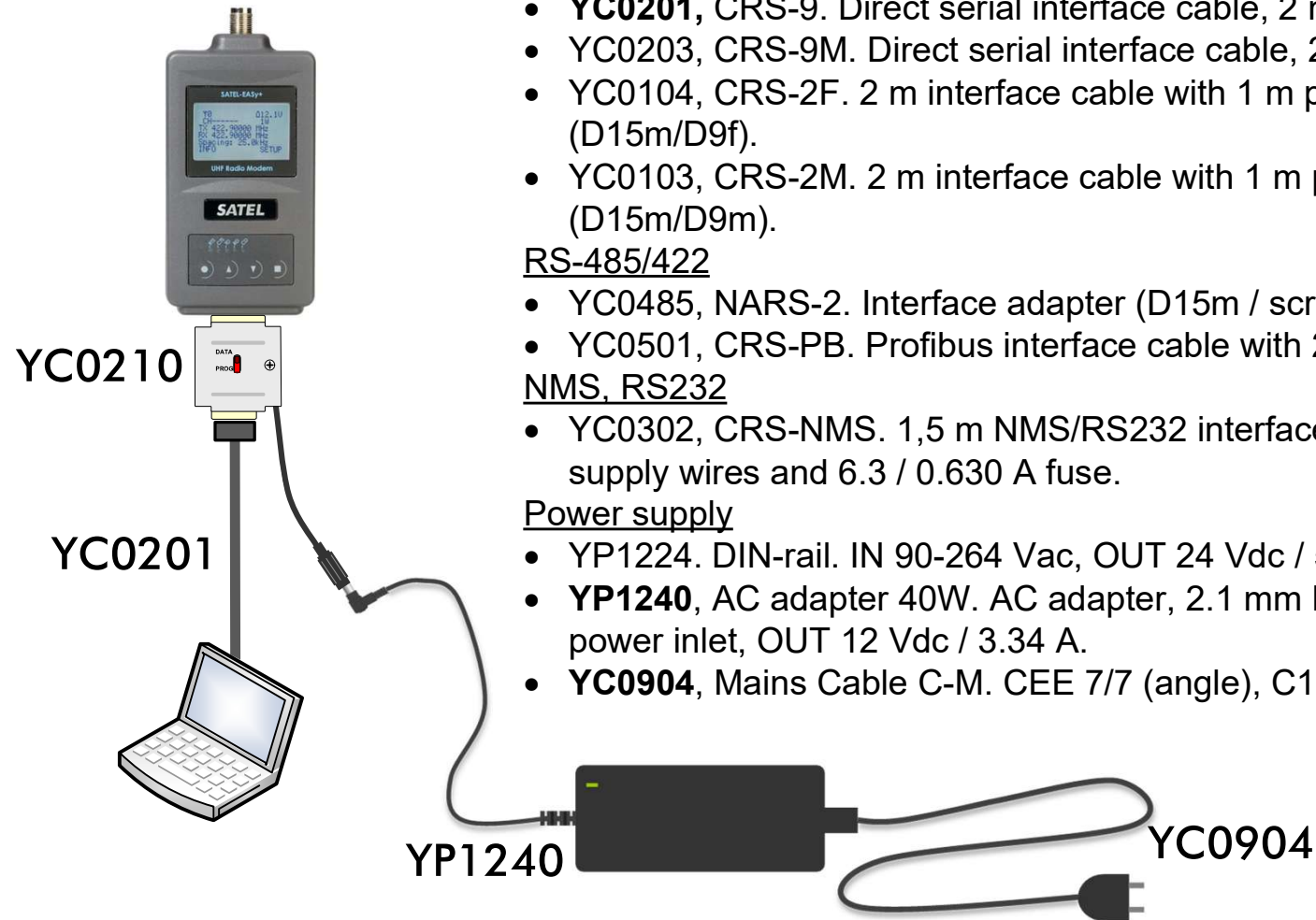

Power, programming and interface cables:

RS-232

- YC0200, NARS-1F. Interface adapter with 900 mA fuse, 2 m power supply wires and programming switch (D15m / D9f).
- YC0204, NARS-1F-4A. As NARS-1F, but with 4A fuse (D15m / D9f).
- **YC0210**, NARS-1F-4A-SC. As NARS-1F-4A, but with 2.1 mm DC socket (D15m / D9f).
- **YC0201**, CRS-9. Direct serial interface cable, 2 m (D9m / D9f).
- YC0203, CRS-9M. Direct serial interface cable, 2 m (D9m / D9m).
- YC0104, CRS-2F. 2 m interface cable with 1 m power supply wires, 6.3 / 0.630 A fuse (D15m/D9f).
- YC0103, CRS-2M. 2 m interface cable with 1 m power supply wires, 6.3 / 0.630 A fuse (D15m/D9m).

RS-485/422

- YC0485, NARS-2. Interface adapter (D15m / screw connectors).
- YC0501, CRS-PB. Profibus interface cable with 2 m power supply wires (D15m / D9m).

NMS, RS232

- YC0302, CRS-NMS. 1,5 m NMS/RS232 interface cable (D15m / 2 x D9f), with 1 m power supply wires and 6.3 / 0.630 A fuse.

Power supply

- YP1224. DIN-rail. IN 90-264 Vac, OUT 24 Vdc / 5 A.
- **YP1240**, AC adapter 40W. AC adapter, 2.1 mm DC jack IN 100-240 Vac, C14 male IEC power inlet, OUT 12 Vdc / 3.34 A.
- **YC0904**, Mains Cable C-M. CEE 7/7 (angle), C13 female IEC

SATEL-EASy+ ETH (ETH/USB/BT)

Configuration setup:

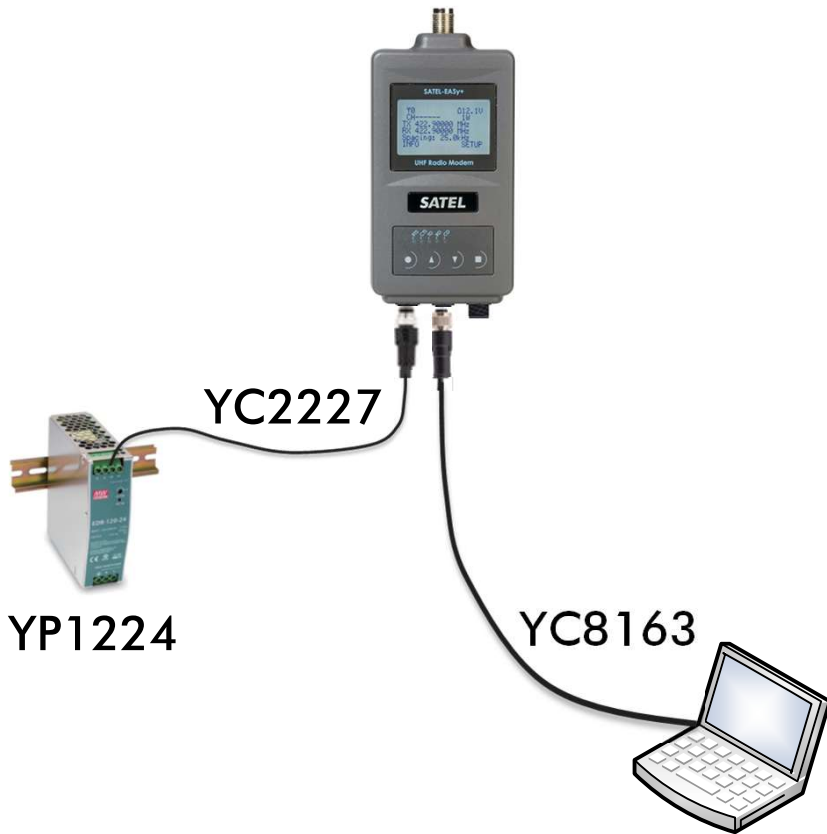

USB:

- **YC8163**, M8 (A-coded 4-pin female) to USB-A connector, 2 meters

ETH:

- **YC1759**, M8 (A-coded 4-pin male) to RJ-45 connector, 2 meters

Power cable:

- **YC2227**, M8 (A-coded 3-pin male) to open ends, 2 meters

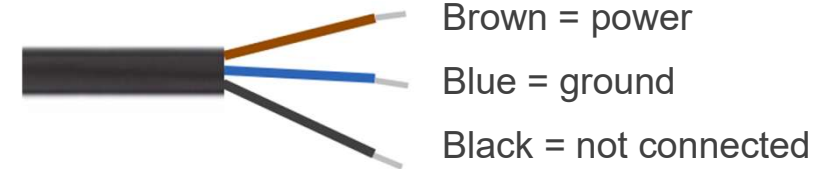

Power supply

- **YP1224**. DIN-rail, IN 90-264 Vac, OUT 24 Vdc / 5 A.

SATEL MCCU-20 and MCCU-10

SATEL Proof-TR489, -TR4+, -R4+ and -TR9

Configuration setup:

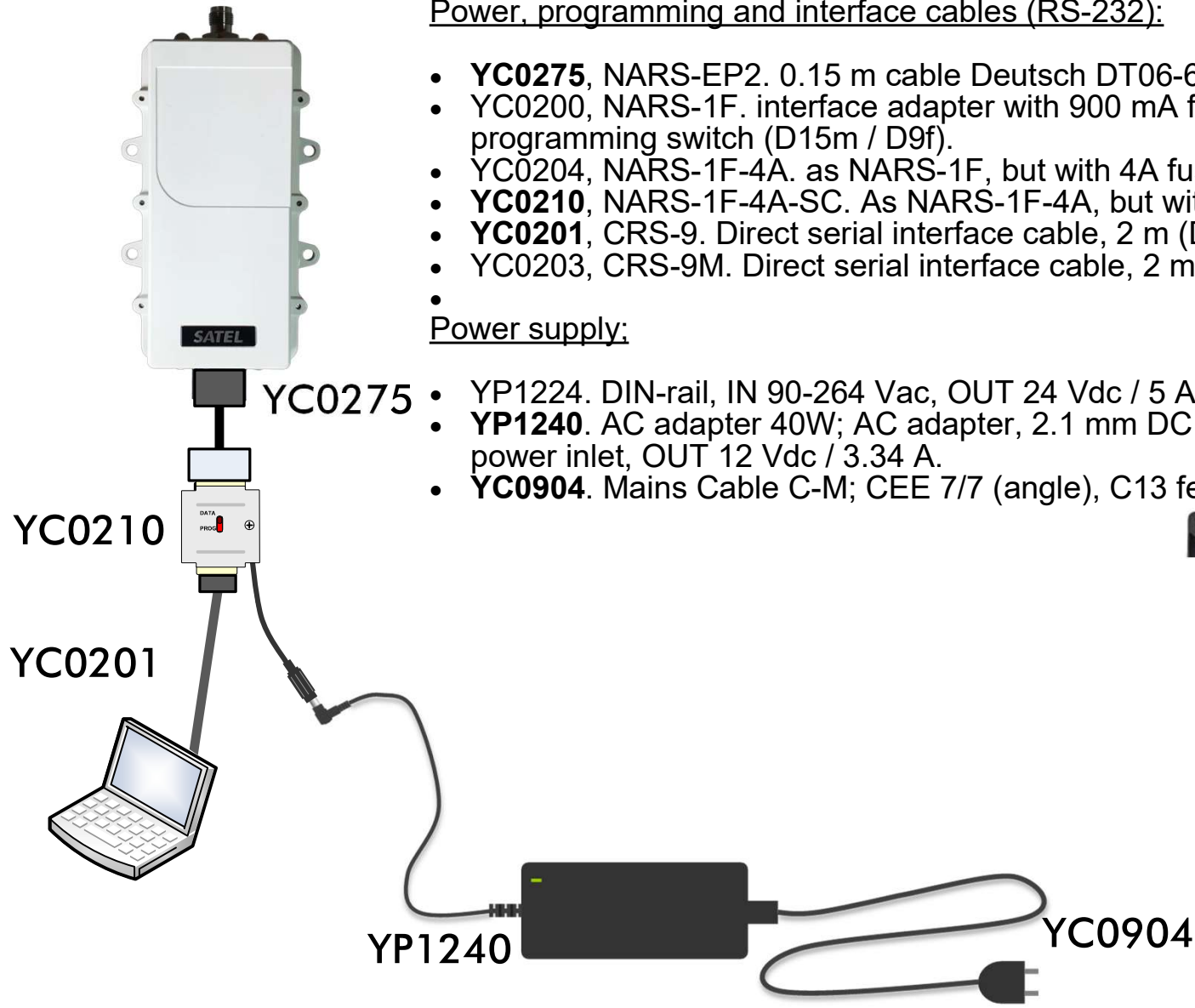

Power, programming and interface cables (RS-232):

- **YC0275**, NARS-EP2. 0.15 m cable Deutsch DT06-6S-CE06 / D15 female.
- **YC0200**, NARS-1F. interface adapter with 900 mA fuse, 2 m power supply wires and programming switch (D15m / D9f).
- **YC0204**, NARS-1F-4A. as NARS-1F, but with 4A fuse (D15m / D9f).
- **YC0210**, NARS-1F-4A-SC. As NARS-1F-4A, but with 2.1 mm DC socket (D15m / D9f).
- **YC0201**, CRS-9. Direct serial interface cable, 2 m (D9m / D9f).
- **YC0203**, CRS-9M. Direct serial interface cable, 2 m (D9m / D9m).
-

Power supply:

- **YP1224**. DIN-rail, IN 90-264 Vac, OUT 24 Vdc / 5 A.
- **YP1240**. AC adapter 40W; AC adapter, 2.1 mm DC jack IN 100-240 Vac, C14 male IEC power inlet, OUT 12 Vdc / 3.34 A.
- **YC0904**. Mains Cable C-M; CEE 7/7 (angle), C13 female IEC.

SATEL-EASy Pro+

Configuration setup:

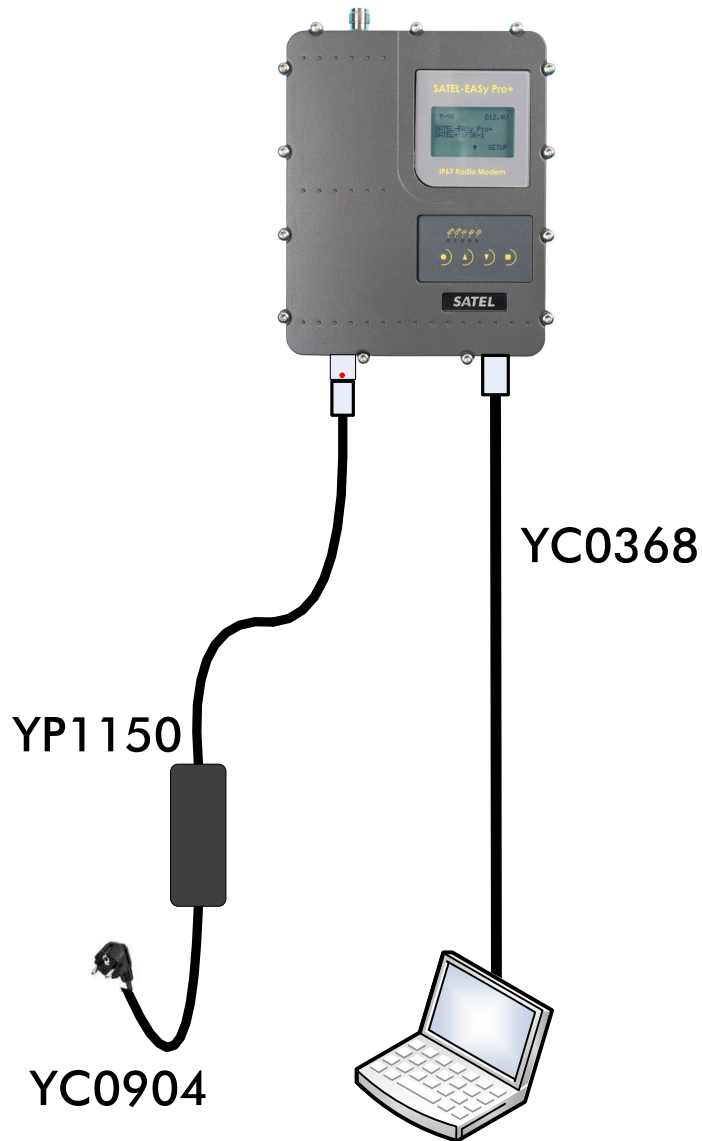

Power, programming and interface cables (RS-232):

- **YC0368**, CRS-35W 8-PIN. Interface cable 2 m (8pin ODU/D9f).
- YC0369, CRS-35W 8-/7-pin ODU. Interface cable 2 m.
- YC0359, CRS-35W 8-/8-pin ODU. Interface cable 2 m.
- YC0359, CRS-35W 8-/8-pin (0/30 deg.) ODU. Interface cable 2 m.
- YC0363, PROG-35W 8-pin. Programming cable 2 m (8pin ODU/D9f).
- YC0240, NARS-ST. 0.4 m cable D15 female / ODU 8-pin male. Between radio and NARS-1F (D15m / D9f) adapter.

USB

- YC0232, data cable RS232 ODU - USB-A (8pin ODU/USB-A), 1.8m.

Power supply

- **YP1150**, power adapter 150W. ODU 2-pin male, C14 male IEC power inlet. IN 100-240 Vac, OUT 12 Vdc/12.5A.
- **YC0904**, Mains Cable C-M. CEE 7/7 (angle), C13 female IEC.
- YP1224, DIN-rail. IN 90-264 Vac, OUT 24 Vdc / 5 A.

Power cables

- YC2957, power cable C-P-Pro+ 2 m, ODU 2-pin male / 4 mm lab plugs.
- YC1353, power cable 2 m, ODU 2-pin male / alligator clip.

SATEL-EASy Pro+

Configuration setup 2:

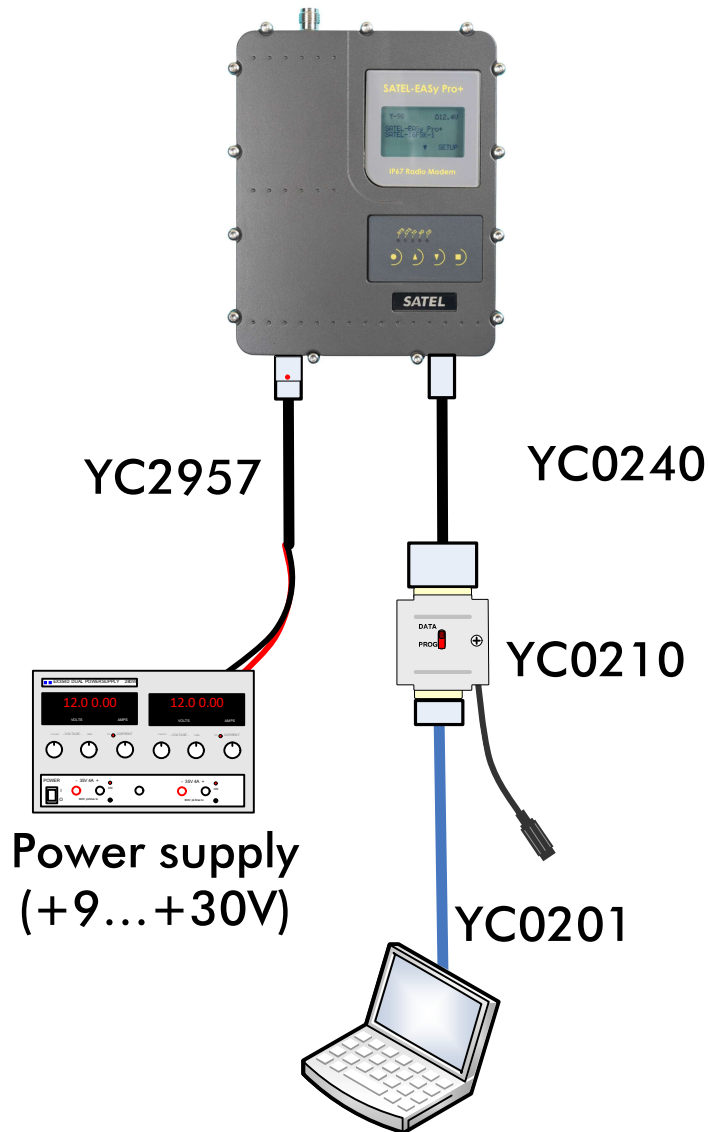

Alternative programming setup with HW PROG:

- **YC0240**, NARS-ST. Interface adapter (8 pin LEMO male / D15 female).
- NARS adapter (D9f-D15m);
 - YC0204, NARS-1F-4A
 - YC0200, NARS-1F
 - **YC0210**, NARS-1F-4A-SCNARS adapter power wires not connected.
- **YC0201**, CRS-9. Direct serial interface cable (D9male / D9female).
- **YC2957**, power cable C-P-Pro+ 2 m, ODU 2-pin male / 4 mm lab plugs.

SATELLINE-3AS VHF

Configuration setup:

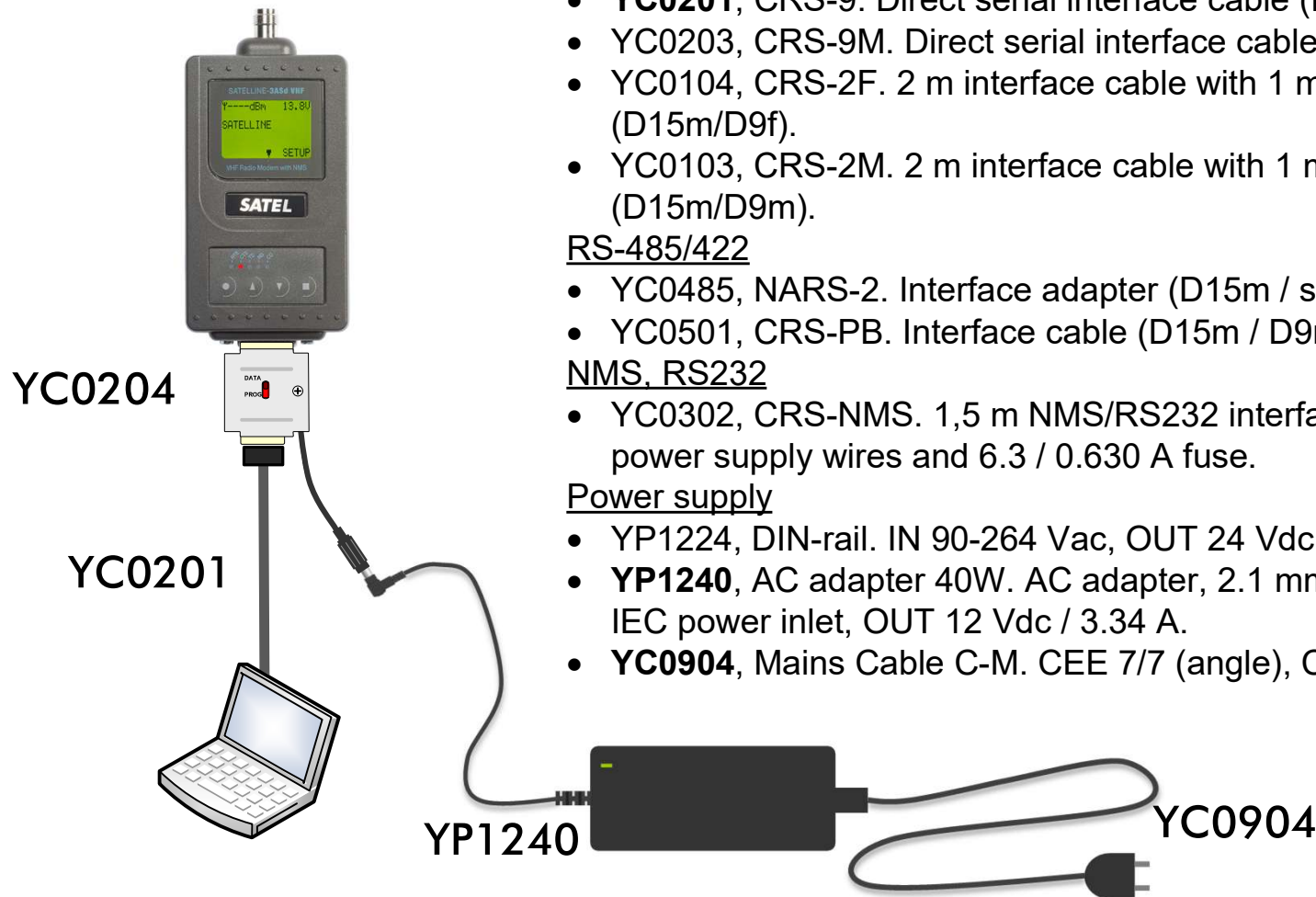

Power, programming and interface cables:

RS232

- YC0200, NARS-1F. Interface adapter with 900 mA fuse, 2 m power supply wires and programming switch (D15m / D9f).
- YC0204, NARS-1F-4A. As NARS-1F, but with 4A fuse (D15m / D9f).
- **YC0210**, NARS-1F-4A-SC. As NARS-1F-4A, but with 2.1 mm DC socket (D15m / D9f).
- **YC0201**, CRS-9. Direct serial interface cable (D9male / D9female).
- YC0203, CRS-9M. Direct serial interface cable, 2 m (D9m / D9m).
- YC0104, CRS-2F. 2 m interface cable with 1 m power supply wires, 6.3 / 0.630 A fuse (D15m/D9f).
- YC0103, CRS-2M. 2 m interface cable with 1 m power supply wires, 6.3 / 0.630 A fuse (D15m/D9m).

RS-485/422

- YC0485, NARS-2. Interface adapter (D15m / screw connectors).
- YC0501, CRS-PB. Interface cable (D15m / D9m).

NMS, RS232

- YC0302, CRS-NMS. 1,5 m NMS/RS232 interface cable (D15m / 2 x D9f), with 1 m power supply wires and 6.3 / 0.630 A fuse.

Power supply

- YP1224, DIN-rail. IN 90-264 Vac, OUT 24 Vdc / 5 A.
- **YP1240**, AC adapter 40W. AC adapter, 2.1 mm DC jack IN 100-240 Vac, C14 male IEC power inlet, OUT 12 Vdc / 3.34 A.
- **YC0904**, Mains Cable C-M. CEE 7/7 (angle), C13 female IEC.