

**SATEL**

Mission-Critical Connectivity

**SATEL-TR4+  
TRANSCEIVER MODULE**

**SATEL-R4+  
RECEIVER MODULE**

**INTEGRATION GUIDE**

**Version 3.0**

## **IMPORTANT NOTICE**

All rights to this manual are owned solely by SATEL Oy (referred to in this user guide as SATEL). All rights reserved. Copying of this manual (without the written permission from the owner) by printing, copying, recording or by any other means, or the full or partial translation of the manual to any other language, including all programming languages, using any electrical, mechanical, magnetic, optical, manual or other methods or devices is forbidden.

SATEL reserves the right to change the technical specifications or functions of its products, or to discontinue the manufacture of any of its products or to discontinue the support of any of its products, without any written announcement and urges its customers to ensure, that the information at their disposal is valid.

SATEL software and programs are delivered "as is". The manufacturer does not grant any kind of warranty including guarantees on suitability and applicability to a certain application. Under no circumstances is the manufacturer or the developer of a program responsible for any possible damages caused by the use of a program. The names of the programs as well as all copyrights relating to the programs are the sole property of SATEL. Any transfer, licensing to a third party, leasing, renting, transportation, copying, editing, translating, modifying into another programming language or reverse engineering for any intent is forbidden without the written consent of SATEL.

**SATEL PRODUCTS HAVE NOT BEEN DESIGNED, INTENDED NOR INSPECTED TO BE USED IN ANY LIFE SUPPORT RELATED DEVICE OR SYSTEM RELATED FUNCTION NOR AS A PART OF ANY OTHER CRITICAL SYSTEM AND ARE GRANTED NO FUNCTIONAL WARRANTY IF THEY ARE USED IN ANY OF THE APPLICATIONS MENTIONED.**

Salu, FINLAND 2026

## RESTRICTIONS ON USE – SATEL-TR4+

**SATEL-TR4+** radio transceiver module has been designed to operate on 403-473 MHz, the exact use of which differs from one region and/or country to another. The user of a radio transceiver module must take care that the said device is not operated without the permission of the local authorities on frequencies other than those specifically reserved and intended for use without a specific permit.

**SATEL-TR4+** is allowed to be used in the following countries. More detailed information is available from the local frequency management authority.

Countries: AE, AT, AU, BE, BG, BR, CA, CH, CY, CZ, DE, DK, EE, ES, FI, FR, GB, GR, HU, HR, IE, IS, IT, JP, KR, LT, LU, LV, MT, NL, NO, PL, PT, RU, RO, SE, SI, SK, TR, US

**WARNING – RF Exposure!** To comply with RF exposure compliance requirements in Europe, USA and Canada maximum antenna gain is 14dBi and a separation distance listed in a table below must be maintained between the antenna of this device and all persons. This device must not be co-located or operating in conjunction with any other antenna or transmitter.

Antenna Gain [dBi]	Separation distance [cm]
0	23
4	36
6	45
8	56
10	71
12	89
14	112

**WARNING!** Users of SATEL-TR4+ radio transceiver module in North America should be aware, that due to the allocation of the frequency band 406.0 – 406.1 MHz for government use only, the use of radio transceiver module on this frequency band without a proper permit is strictly forbidden.

### Host product labeling requirements

SATEL-TR4+ is intended to be integrated into a host device. Therefore, the SATEL-TR4+ product related FCC ID and IC ID must be visible in the host device chassis:

**FCC ID: MRBSATEL-TA40**

**IC: 2422A-SATELTA40**

**NOTE!**

According to the requirements of the FCC, the integrator should make sure that the SATEL-TR4+ is compliant to part 15C while integrated in the host device. Output power and spurious emissions should be verified.

**NOTE!**

This equipment has been tested and found to comply with the limits for a Class B digital device, pursuant to part 15 of the FCC Rules. These limits are designed to provide reasonable protection against harmful interference in a residential installation. This equipment generates, uses and can radiate radio frequency energy and, if not installed and used in accordance with the instructions, may cause harmful interference to radio communications. However, there is no guarantee that interference will not occur in a particular installation. If this equipment does cause harmful interference to radio or television reception, which can be determined by turning the equipment off and on, the user is encouraged to try to correct the interference by one or more of the following measures:

- Reorient or relocate the receiving antenna.
- Increase the separation between the equipment and receiver.
- Connect the equipment into an outlet on a circuit different from that to which the receiver is connected.
- Consult the dealer or an experienced radio/TV technician for help.

## **PRODUCT CONFORMITY**

Under the sole responsibility of manufacturer SATEL Oy declares that SATEL-TR4+ radio transceiver module and SATEL-R4+ receiver module are in compliance with the essential requirements (radio performance, electromagnetic compatibility and electrical safety) and other relevant provisions of Directives 2014/53/EU and 2011/65/EU and Council recommendation 1999/519/EC. Therefore, the equipment is labeled with the following CE-marking. The operating frequency range of the device is not harmonized throughout the market area, and the local spectrum authority should be contacted before the usage of the radio module.



## **WARRANTY AND SAFETY INSTRUCTIONS**

Read these safety instructions carefully before using the product:

-Warranty will be void if the product is used in any way that is in contradiction with the instructions given in this manual

-The radio transceiver module is only to be operated at frequencies allocated by local authorities, and without exceeding the given maximum allowed output power ratings. SATEL and its distributors are not responsible if any products manufactured by it are used in unlawful ways.

-The devices mentioned in this manual are to be used only according to the instructions described in this manual. Faultless and safe operation of the devices can be guaranteed only if the transport, storage, operation and handling of the device are appropriate. This also applies to the maintenance of the products.

## HOST INTEGRATION

To ensure compliance with all non-transmitter functions the host manufacturer is responsible for ensuring compliance with the module(s) installed and fully operational. For example, if a host was previously authorized as an unintentional radiator under the Declaration of Conformity procedure without a transmitter certified module and a module is added, the host manufacturer is responsible for ensuring that after the module is installed and operational the host continues to be compliant with the Part 15B unintentional radiator requirements. This module is certified for Fixed and Mobile Applications only, for portable applications you will require a new certification.

This device has been modularly approved. Model name, FCC and Industry Canada identifiers of this product must appear on the outside label of the end-user equipment.

Host labelling example:

**Model Name: SATEL-TA40**

**Contains FCC ID: MRBSATEL-TA40**

**IC: 2422A-SATELTA40**

**This device complies with part 15 of the FCC rules. Operation is subject to the following two conditions: (1) This device may not cause harmful interference, and (2) this device must accept any interference received, including interference that may cause undesired**

## TABLE OF CONTENTS

<b>RESTRICTIONS ON USE – SATEL-TR4+ .....</b>	<b>2</b>
<b>PRODUCT CONFORMITY.....</b>	<b>4</b>
<b>WARRANTY AND SAFETY INSTRUCTIONS .....</b>	<b>5</b>
<b>HOST INTEGRATION .....</b>	<b>6</b>
<b>TABLE OF CONTENTS .....</b>	<b>7</b>
<b>1 INTRODUCTION .....</b>	<b>11</b>
1.1 Terms and abbreviations.....	11
1.2 Description of the product .....	11
<b>2 TECHNICAL SPECIFICATIONS.....</b>	<b>12</b>
2.1 Absolute maximum ratings.....	12
2.2 DC electrical specifications.....	12
2.3 Specifications, SATEL-TR4+ and SATEL-R4+ .....	13
<b>3 TIME PARAMETERS FOR STARTUP AND SHUTDOWN SEQUENCES.....</b>	<b>16</b>
3.1 Startup sequence .....	16
3.2 Shutdown and ENA sequences .....	17
<b>4 ELECTRICAL INTERCONNECTION.....</b>	<b>18</b>
4.1 DTE connector.....	18
4.2 Pin order of the DTE connector .....	19
4.3 Equivalent I/O Schematics .....	20
4.4 RF interface .....	21
4.5 VCC_IO pin .....	22
4.6 Service pin.....	22

<b>4.7</b>	<b>Stat pin .....</b>	<b>22</b>
<b>4.8</b>	<b>VCC pins .....</b>	<b>23</b>
<b>4.9</b>	<b>UART pins .....</b>	<b>23</b>
<b>4.10</b>	<b>GPIO pins .....</b>	<b>23</b>
<b>5</b>	<b>MECHANICAL CONSIDERATIONS .....</b>	<b>24</b>
<b>5.1</b>	<b>Fixing device to host .....</b>	<b>24</b>
<b>5.2</b>	<b>Heat transfer.....</b>	<b>24</b>
<b>6</b>	<b>OPERATING MODES .....</b>	<b>25</b>
<b>6.1</b>	<b>Safe mode .....</b>	<b>25</b>
<b>6.2</b>	<b>Power up / power down scenarios.....</b>	<b>25</b>
<b>6.3</b>	<b>Sleep Mode .....</b>	<b>26</b>
<b>6.4</b>	<b>Power Save Mode.....</b>	<b>26</b>
<b>6.5</b>	<b>Restart .....</b>	<b>27</b>
<b>7</b>	<b>CONFIGURATION.....</b>	<b>28</b>
<b>7.1</b>	<b>SATEL NETCO DEVICE software .....</b>	<b>28</b>
<b>7.2</b>	<b>SATEL Configuration Manager software.....</b>	<b>28</b>
<b>7.3</b>	<b>Changing parameters using SL commands.....</b>	<b>28</b>
7.3.1	SL Commands.....	29
7.3.2	Command Mode .....	30
<b>8</b>	<b>SERIAL INTERFACE .....</b>	<b>31</b>
<b>8.1</b>	<b>Pause length .....</b>	<b>31</b>
<b>8.2</b>	<b>Data buffering.....</b>	<b>32</b>
<b>9</b>	<b>RADIO PARAMETERS .....</b>	<b>33</b>
<b>9.1</b>	<b>Transmitter.....</b>	<b>33</b>
<b>9.2</b>	<b>Receiver.....</b>	<b>34</b>
<b>9.3</b>	<b>Encryption.....</b>	<b>35</b>

<b>9.4</b>	<b>Radio state .....</b>	<b>36</b>
<b>9.5</b>	<b>Priority RX/TX.....</b>	<b>36</b>
<b>9.6</b>	<b>Forward Error Correction (FEC) .....</b>	<b>36</b>
<b>9.7</b>	<b>Error checking .....</b>	<b>37</b>
<b>9.8</b>	<b>TX Delay .....</b>	<b>37</b>
<b>9.9</b>	<b>Add RSSI to data .....</b>	<b>37</b>
<b>9.10</b>	<b>Separate TX/RX frequencies .....</b>	<b>37</b>
<b>9.11</b>	<b>User data whitening .....</b>	<b>38</b>
<b>9.12</b>	<b>Call Sign .....</b>	<b>38</b>
<b>9.13</b>	<b>Channel list .....</b>	<b>38</b>
<b>9.14</b>	<b>Repeater –mode .....</b>	<b>40</b>
<b>9.15</b>	<b>Radio compatibility .....</b>	<b>40</b>
9.15.1	Settings in Pacific Crest/TRIMTALK compatibility modes .....	42
9.15.2	Repeater function.....	44
9.15.3	Support for Local / Remote addresses .....	44
9.15.4	Transmission delays.....	45
<b>10</b>	<b>TEST MODES .....</b>	<b>47</b>
<b>10.1</b>	<b>Short Block Test.....</b>	<b>47</b>
<b>10.2</b>	<b>Long Block Test .....</b>	<b>47</b>
<b>11</b>	<b>DEFAULT DELIVERY VALUES .....</b>	<b>48</b>
<b>12</b>	<b>CONSIDERATIONS.....</b>	<b>49</b>
<b>12.1</b>	<b>EMI Interferers .....</b>	<b>49</b>
<b>12.2</b>	<b>Electrostatic discharge .....</b>	<b>50</b>
<b>12.3</b>	<b>Using the device in unmanned high reliability applications .....</b>	<b>50</b>
<b>12.4</b>	<b>Proposals for more reliable radio link.....</b>	<b>51</b>
<b>13</b>	<b>APPENDIX .....</b>	<b>52</b>
<b>13.1</b>	<b>Module dimensions.....</b>	<b>52</b>

**13.2 SL commands ..... 53**  
13.2.1 Encryption commands..... 62

# 1 INTRODUCTION

SATEL Oy is a Finnish electronics and Telecommunications company specializing in the design and manufacture of wireless data communication products. SATEL designs, manufactures and sells radio modems intended for use in applications ranging from data transfer to alarm relay systems. End users of SATEL products include both public organizations and private individuals.

SATEL Oy is the leading European manufacturer of radio modems. SATEL radio modems have been certified in most European countries and also in many non-European countries.

This document is the integration guide for the SATEL-TR4+ radio transceiver and SATEL-R4+ radio receiver module. It is intended to describe how to use these modules and how to integrate those into a host device.

## 1.1 Terms and abbreviations

Abbreviation	Description
CTS	Clear To Send, handshaking signal used in asynchronous communication.
DTE	Data Terminal Equipment (typically computer, terminal...)
ESD	Electrostatic discharge
RD	Receive Data
TD	Transmit Data
RTS	Ready To Send, handshaking signal used in asynchronous communication.
RAM	Random Access Memory
LDO	Low dropout regulator
UHF	Ultra High Frequency
RF	Radio Frequency
CPU	Central processing unit

## 1.2 Description of the product

The SATEL-R4+ is a UHF receiver module, which receives data from the UHF frequency band. The SATEL-TR4+ is a UHF radio transceiver module, which transmits and receives data from the UHF frequency band. The modules are designed to be as compact and power efficient as possible. They have been developed to be especially suitable for integration into battery powered and space constrained host applications benefiting from UHF communications.

The transceiver module transmits and receives data via the Air interface, modulates and demodulates, encodes and decodes the data and sends the received data payload to the DTE port. The DTE interface is used to provide power and communicate with the module.

## 2 TECHNICAL SPECIFICATIONS

### 2.1 Absolute maximum ratings

Absolute maximum ratings for voltages on different pins are listed in the following table. Exceeding these values will cause permanent damage to the module.

Parameter	Min	Max
Voltage at VCC_IN	0 V	+6 V
Voltage at ENA_MOD	0 V	+6 V
Voltage at VCC_IO	0 V	3.75 V
Voltage at digital inputs (except ENA_MOD)	0 V	3.75 V
Voltage at digital outputs	0 V	3.75 V

Note. All voltages are referenced to GND.

### 2.2 DC electrical specifications

Recommended operating conditions:

Parameter	Condition	Min	Max	Units
VCC_IN		+3.8	+5.5	V
ENA_MOD, Vlow		0	0.2	V
ENA_MOD, Vhigh		1.2	VCC_IN	V
VCC_IO		1.8	3.3	V
Logic input, Vlow	1.8 V < VCC_IO < 3.3V	0	0.3	V
Logic input, Vhigh	1.8 V < VCC_IO < 3.3V	0.9*VCC_IO	VCCIO	V
Logic output, Vlow	1.8 V < VCC_IO < 3.3V	0	0.5	V
Logic output, Vhigh	1.8 V < VCC_IO < 3.3V	0.6*VCC_IO	VCCIO	V
Logic output, max current	All logic output except STAT pin.	-	4	mA
Logic output, max current, STAT pin		-	12	mA

## 2.3 Specifications, SATEL-TR4+ and SATEL-R4+

Receiver part specifications applies to SATEL-R4+ receiver module.

SATEL-TR4+ complies with the following international standards:

EN 300 113 V2.2.1 (4FSK FEC ON and 8FSK FEC ON)      IEC 62368-1  
EN 301 489-1, -5      FCC Part 90      FCC Part 15

	RECEIVER	TRANSMITTER	Note!
Frequency Range <sup>1</sup>	403 - 473 MHz		
Tuning range	70 MHz		
Minimum RF Frequency Step	6.25 kHz		10 kHz @ 20 kHz channel spacing
Channel Bandwidth	12.5 kHz, 20 kHz, 25 kHz		
Frequency Stability	±0.5 ppm		-40°C...+85°C (Reference to +25°C)
Maximum Receiver Input Power without Damage	+3 dBm		
Maximum Receiver Input Power without Transmission Errors	-10 dBm		4FSK, 25 kHz, FEC ON
Sensitivity <sup>2</sup> BER = 10 <sup>-2</sup>	typ. -113 dBm		4FSK, 25 kHz, FEC ON
	typ. -115 dBm		4FSK, 12.5 kHz, FEC ON
	typ. -111 dBm		8FSK, 25 kHz, FEC ON
	typ. -112 dBm		8FSK, 12.5 kHz, FEC ON
	typ. -102 dBm		16FSK, 25 kHz, FEC ON
	typ. -104 dBm		16FSK, 12.5 kHz, FEC ON
Blocking <sup>2</sup> BER = 10 <sup>-2</sup>	typ. -17 dBm		4FSK, 25 kHz, FEC ON
	typ. -20 dBm		4FSK, 12.5 kHz, FEC ON
	typ. -18 dBm		8FSK, 25 kHz, FEC ON
	typ. -17 dBm		8FSK, 12.5 kHz, FEC ON
	typ. -29 dBm		16FSK, 25 kHz, FEC ON
	typ. -25 dBm		16FSK, 12.5 kHz, FEC ON
Intermodulation Response Rejection <sup>2</sup> BER = 10 <sup>-2</sup>	typ. -35 dBm		4FSK, 25 kHz, FEC ON
	typ. -37 dBm		4FSK, 12.5 kHz, FEC ON
	typ. -36 dBm		8FSK, 25 kHz, FEC ON
	typ. -36 dBm		8FSK, 12.5 kHz, FEC ON
	typ. -44 dBm		16FSK, 25 kHz, FEC ON
	typ. -41 dBm		16FSK, 12.5 kHz, FEC ON
CO-Channel Rejection <sup>2</sup> BER = 10 <sup>-2</sup>	typ. 8 dB		4FSK, 25 kHz, FEC ON
	typ. 8 dB		4FSK, 12.5 kHz, FEC ON
	typ. 10 dB		8FSK, 25 kHz, FEC ON
	typ. 11 dB		8FSK, 12.5 kHz, FEC ON
	typ. 21 dB		16FSK, 25 kHz, FEC ON
	typ. 20 dB		16FSK, 12.5 kHz, FEC ON

Adjacent Channel Selectivity <sup>2</sup> BER = 10 <sup>-2</sup>	typ. -33 dBm		4FSK, 25 kHz, FEC ON
	typ. -36 dBm		4FSK, 12.5 kHz, FEC ON
	typ. -34 dBm		8FSK, 25 kHz, FEC ON
	typ. -34 dBm		8FSK, 12.5 kHz, FEC ON
	typ. -43 dBm		16FSK, 25 kHz, FEC ON
	typ. -40 dBm		16FSK, 12.5 kHz, FEC ON
Spurious Rejection	typ. -35 dBm		4/8/16FSK, 12.5 and 25 kHz, FEC ON
Transmitter Power		0.01, 0.02, 0.05, 0.1, 0.2, 0.5, 1 W	
Communication Mode	Half-Duplex		
Frequency Change Time	typ. 20 ms		Time required for switching from one RF frequency to another
Adjacent Channel Power		<-60 dBc	TX-mode, 12.5 and 25 kHz. Acc. to EN 300 113 v2.2.1
Carrier power stability		< ±1.5 dB	During transmission.

<sup>1</sup> Firmware rejects 405.925...406.176 MHz frequencies (406.000–406.100 MHz when region setting is set to EU). The frequency band is reserved internationally for emergency transmitters as specified by FCC reference FCC 04-75<sup>1</sup>

<sup>2</sup> According to EN 300 113 V2.2.1 measurement setup.

	<b>DATA MODULE</b>	
Electrical Interface	CMOS-UART Inputs and outputs referred to IO Voltage processed by user (1.8-3.3V) RTS, CTS, RX, TX, +VCC, GND	
Interface Connector	1.27 mm pitch socket	Samtec 20-pin through hole, CLP-110-02-L-D-K-TR
Data speed of Serial interface	9600 – 115200 bps	
Data speed of Radio Air Interface	<u>*4FSK FEC OFF / ON:</u> 19200 / 14400 bps (25 kHz) 9600 / 7200 bps (12.5 kHz) <u>8FSK FEC OFF / ON:</u> 28800 / 19200 bps (25 kHz) 14400 / 9600 bps (12.5 kHz) <u>16FSK FEC ON:</u> 28800 bps (25 kHz) 14400 bps (12.5 kHz)	
Air Interface Encryption	AES128, AES256 (DRM option)	
Data Format	Asynchronous data	
Modulation	4-, 8-, 16FSK	

	<b>GENERAL</b>	
Operating voltage	+3.8...+5.5V	
Typical Power Consumption 403...473 MHz	Sync search typ. 890 mW	RX-mode
	Receiving data typ. 860 mW	RX-mode
	SLEEP1: typ. 300 mW	RX-mode
	typ. 4.8 W @ 1 W RF out	Wake-up time typically 33 ms  TX-mode, Continuous, 50 Ω, CHBW 25.0 kHz
	typ. 3.8 W @ 0.5 W RF out	
	typ. 2.9 W @ 0.2 W RF out	
typ. 2.3 W @ 0.1 W RF out		
Inrush Current, DC voltage turned ON	< typ. 17 A, duration < typ. 9 μs	
Temperature Range	-20 °C ...+55 °C	
Temperature Ranges	-30 °C ...+70 °C	
	-40 °C ...+85 °C	
Vibration	20 G	20 Hz ... 2 kHz sinusoidal/random
ESD <sup>1</sup>	± 10 kV	Antenna connector. Acc. to EN61000-4-2; 150pF/330Ω
	± 8 kV	DTE connector. Acc. to EN61000-4-2; 150pF/330Ω
Antenna Connector	50 Ω, HIROSE U.FL compatible	I-PEX 20279-001 -E-01
Construction	PWB with sheet metal EMI shields	
Size L x W x T	57 x 36 x 6.9 mm	
Weight	20 g	

Test condition  $V_{CC} = 4.0\text{ V}$  and  $T_A = 25\text{ °C}$

- <sup>1</sup> Measured under normal ambient conditions,  $T_A = 25\text{ °C}$ . When the device is used in different environment, the results may change significantly. It is recommended to use external ESD protection in demanding conditions.

## 3 TIME PARAMETERS FOR STARTUP AND SHUTDOWN SEQUENCES

The following table shows the recommended times for startup and shutdown sequences.

Parameter	Recom. Time (*)	Explanation
$t_{vccin-ena}$	>2 ms	VCC_IN must be high before ENA_MOD is high
$t_{enamod-io}$	>2 ms	ENA_MOD must be high before VCC_IO is high
$t_{enamod-cts}$	$100\text{ ms} < t_{enamod-cts} < 500\text{ ms}$	CTS ready settling time
$t_{vccio-cts}$	>2 ms	VCC_IO must be high before CTS is ready
$t_{vccio-gpio}$	>2 ms	VCC_IO must be high before GPIO PINS are active
$t_{gpio-cts}$	>0 ms	GPIOs must be active before CTS is ready
$t_{enamod-gpio}$	>80 ms	Input pins must be low after ENA MOD is low
$t_{gpio-vccio}$	>0 ms	GPIOs must be low before VCC_IO is low
$t_{vccio-vccin}$	>0 ms	VCC_IO must be low before VCC is low

### 3.1 Startup sequence

The following diagram will describe the startup sequence.

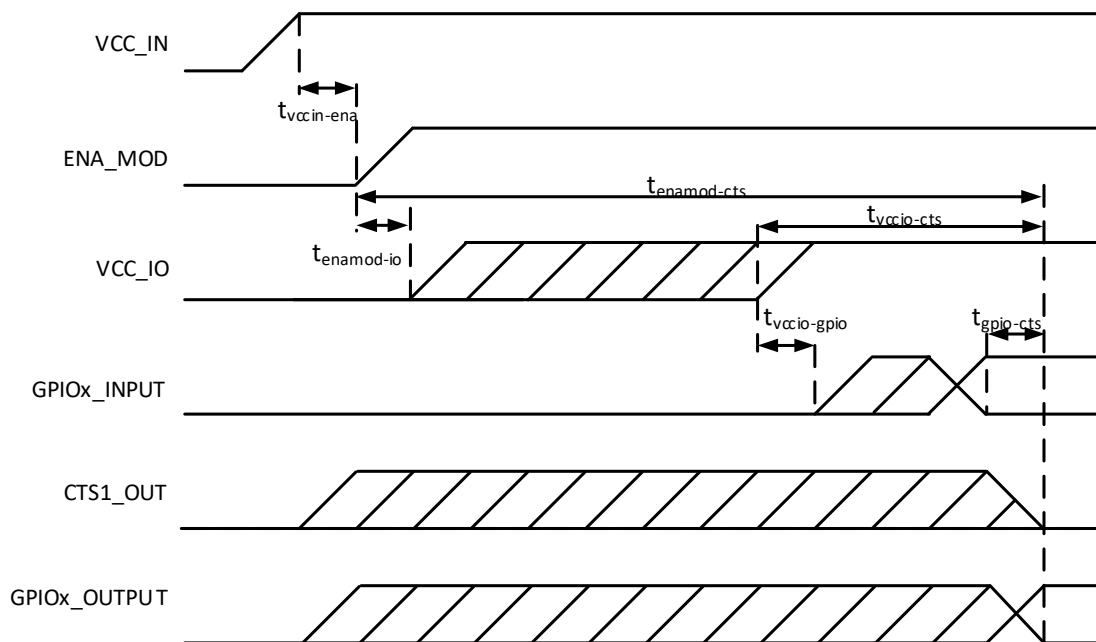

Figure 3.1 Startup sequence.

### 3.2 Shutdown and ENA sequences

The following diagrams will describe the shutdown and ENA sequences.

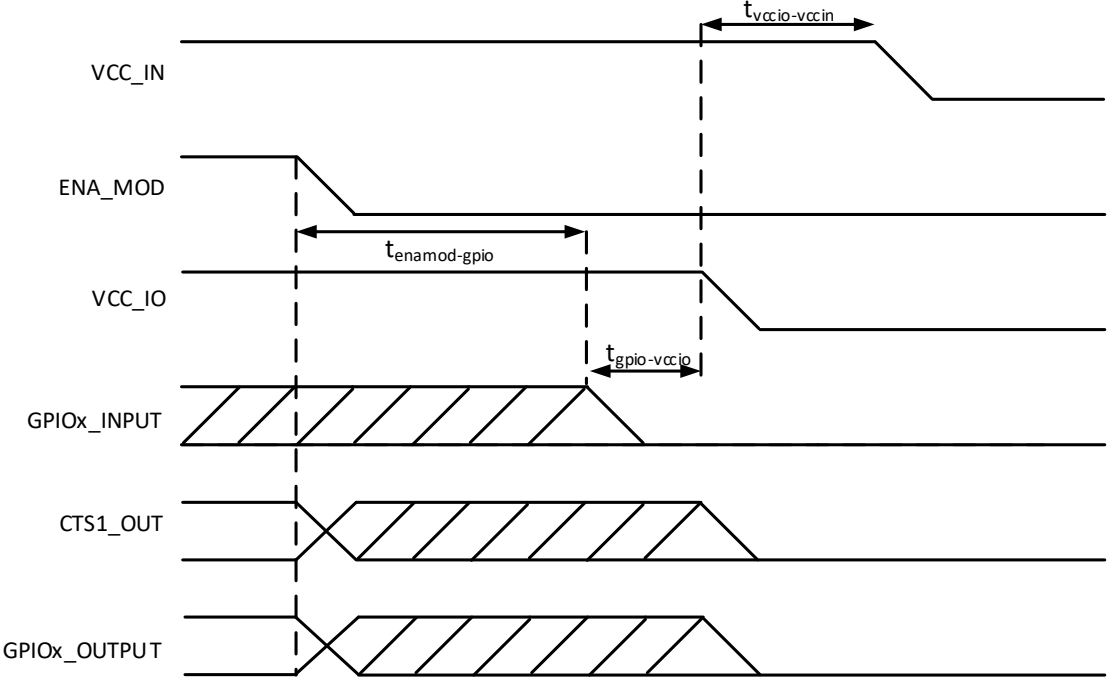

Figure 3.2 Shutdown sequence.

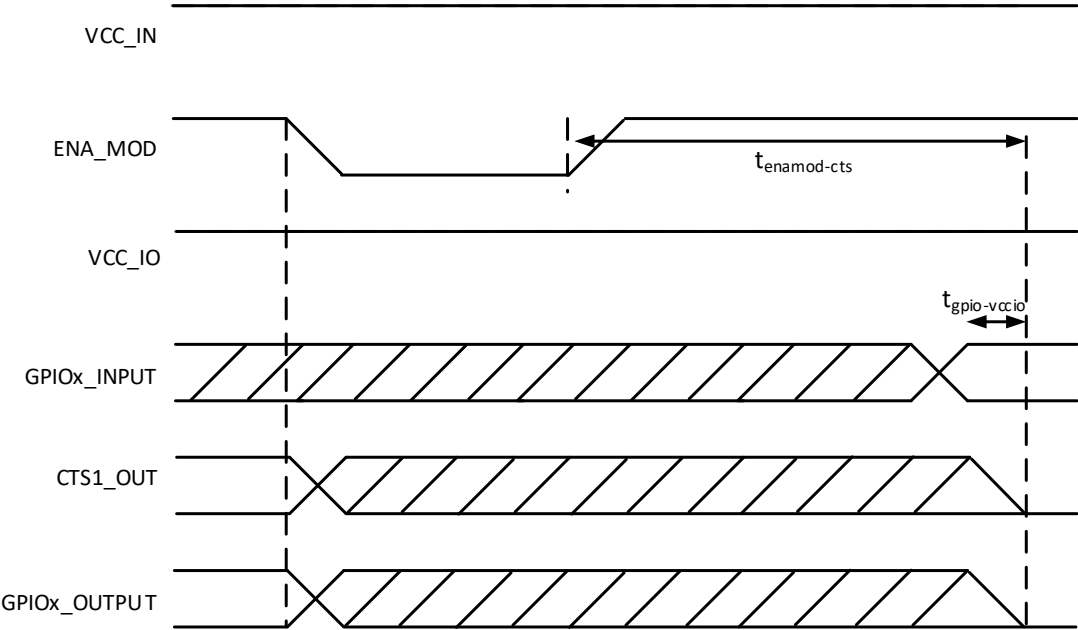
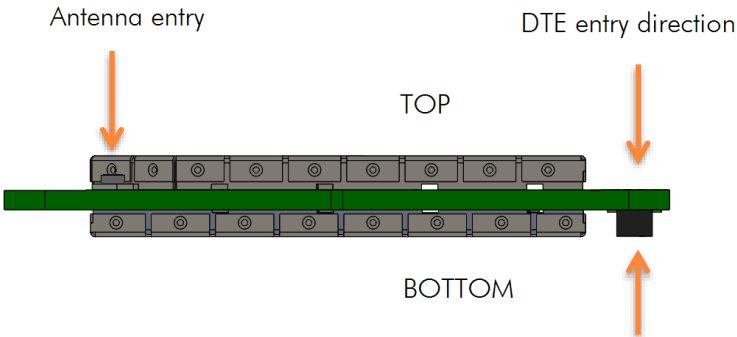

Figure 3.3 ENA sequence.

## 4 ELECTRICAL INTERCONNECTION

### 4.1 DTE connector

The DTE connector is a 20-pin pass-through connector. Connector is female two row 1.27 mm pitch. This connector allows the pin to enter the connector from the bottom side and protrude thru the module PCB to the top side, allowing flexible mounting heights with various pin lengths. Alternative DTE connector assembly variants available. DTE connector assembled either BOTTOM or TOP side of the module.



**Figure 4.1** The side view of the module with connection directions.

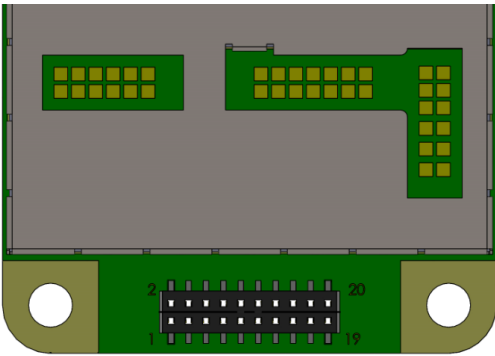

**Figure 4.2** Pin numbering of 1.27 mm pitch DTE connector. View from bottom side of unit.

## 4.2 Pin order of the DTE connector

Direction **IN** is data from DTE (Data Terminal Equipment) to the radio transceiver module.  
Direction **OUT** is data from the radio module to the DTE.

The equivalent I/O schematic figures are shown in the next chapter.

Pin no.	Equivalent I/O schematic	Signal name	Type	Direction	Pin state	Description
1,2	Figure 1	VCC_IN	POWER	IN	External Voltage	DC input
3,4	-	GND	GND	-	External Ground	Ground reference for power and signals
5	Figure 2	VCC_IO	POWER	IN	External Voltage	Device IO driver input
6	Figure 7	ENA_MOD	IO	IN	Internal Pull Down	Module ENA pin
7	Figure 3	RD1	CMOS	OUT	Output Driver	Receive data, active low.
8	Figure 3	CTS1	CMOS	OUT	Output Driver	Clear To Send, active low.
9	Figure 6	TD1	CMOS	IN	Internal Pull Up	Transmit Data, active low.
10	Figure 6	RTS1	CMOS	IN	Internal Pull Up	Ready to send, active low.
11	Figure 4	GPIO1 (RD2)	CMOS	OUT	Internal Pull Down	*)
12	Figure 4	GPIO2	CMOS	OUT	Internal Pull Down	*)
13	Figure 6	GPIO3 (TD2)	CMOS	IN	Internal Pull Up	*)
14	Figure 6	GPIO4	CMOS	IN	Internal Pull Up	*)
15	Figure 5	STAT	CMOS	OUT	Output Driver	Various sequences (section 4.7).
16	Figure 6	GPIO5	CMOS	IN	Internal Pull Up	*)
17	Figure 6	$\overline{\text{SERVICE}}$	CMOS	IN	Internal Pull Up	Input for service access, active low. See separate section of the manual (section 4.6).
18	Figure 4	GPIO6	CMOS	OUT	Internal Pull Down	*)
19	Figure 4	GPIO7	CMOS	OUT	Internal Pull Down	*)
20	Figure 4	GPIO8	CMOS	OUT	Internal Pull Down	Reserved for future use.

\*) See separate document: TIL-0026\_SATEL-Radio-Modules\_GPIO-Interface.pdf

### 4.3 Equivalent I/O Schematics

The module input-output equivalent circuits are shown in the figure and the component values in the table below.

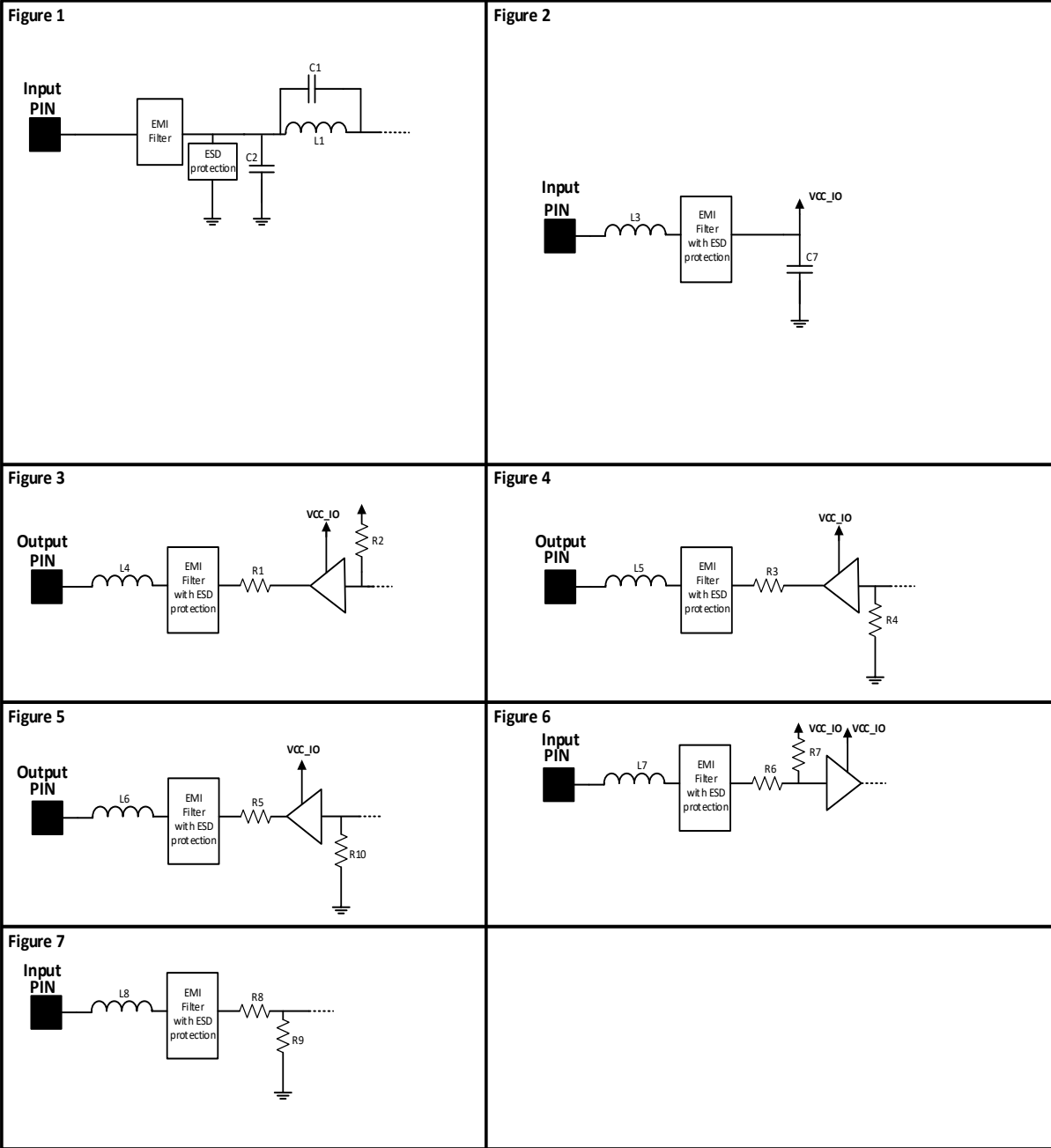

Figure 4.3 The module input-output equivalent circuits.

Component values of the equivalent schematics:

Component	Value	Note
C1	6.8 pF	
C2	1 uF	
L1	220 nH	
L3	1000 $\Omega$ +- 25%	Measured Impedance at 100MHz
C7	100 nF	
L4	1000 $\Omega$ +- 25%	Measured Impedance at 100MHz
R1	330 $\Omega$	
R2	100 k $\Omega$	
L5	1000 $\Omega$ +- 25%	Measured Impedance at 100 MHz
R3	330 $\Omega$	
R4	100 k $\Omega$	
L6	1000 $\Omega$ +- 25%	Measured Impedance at 100 MHz
R5	330 $\Omega$	
L7	1000 $\Omega$ +- 25%	Measured Impedance at 100 MHz
R6	330 $\Omega$	
R7	100 k $\Omega$	
L8	1000 $\Omega$ +- 25%	Measured Impedance at 100MHz
R8	1 k $\Omega$	
R9	>1 M $\Omega$	
R10	100 k $\Omega$	

#### 4.4 RF interface

The antenna interface is a 50  $\Omega$  coaxial connector. Matching networks are not included on the module and should be placed in the host application if the antenna is not 50  $\Omega$ . The HIROSE U.FL compatible connector is located on the TOP side of the board.

NOTE! The used connector has gold plated contacts - whereas a standard HIROSE U-FL has silver plated contacts.

If silver - gold joints are not allowed in your product, use gold plated cable-connector to mate to this device.

#### **NOTE!**

Setting the transmitter output power to such a level that exceeds the regulations set forth by local authorities is strictly forbidden. The setting and/or using of non-approved power levels may lead to prosecution. SATEL and its distributors are not responsible for any illegal use of its radio equipment and are not responsible in any way of any claims or penalties arising from the operation of its radio equipment in ways contradictory to local regulations and/or requirements and/or laws.

## 4.5 VCC\_IO pin

VCC\_IO pin determines the voltage level of UART signals and the voltage level of GPIO output signals. VCC\_IO level also determines GPIO LOW/HIGH levels on each GPIO and UART input pins.

## 4.6 Service pin

The SERVICE pin is used to set the UART1 into a known state. Pulling this pin LOW will activate the service mode, set the UART1 into 38400, 8, N, 1 and temporarily disable the radio interface functions (Tx/Rx). This is intended for service access of the module, to have a known serial port setting in order to provide easy access to module settings.

The pin does not affect any permanent settings, nor does it change the mode of the module. It is recommended to pull high or pull up by resistor to VCC\_IO to return serial port 1 into the configured state. When service pin is LOW the SL Commands are temporary forced at ON -state.

## 4.7 Stat pin

The STAT-pin indicates the status of the device. It can be used to drive or sink a LED current using a proper series resistor. STAT-pin drive or sink capability is +/-10mA at 3.3 V. It is recommended to use VCC\_IO for LED current.

Notice that if STAT-pin is used to sink LED current, LED behavior is opposite to driving scheme. The behavior of the STAT pin is described down below.

Blink cycle	Mode
"1" - statically	Module is operational "searching for a new frame"
"0" for the endurance of the received frame.	"0" when module is receiving data from air interface. In practical cases will toggle at the frequency of the data packets on the air interface.
"0" statically	Module is in sleep1 mode
The pin is toggled in transmission interval	Module is sending data Over the Air
Pin is toggled in 1 s interval	Module has the connection to configuration SW tool.
Pin is toggled in 500 ms interval	SL command mode set to <b>OFF</b> and SL commands enabled using "+" "+" sequence, section 7.3.2.
Pin is toggled in 250 ms interval	Module has detected a fault, fault codes can be read via SW tools.

## **4.8 VCC pins**

VCC pins are to feed operating voltage to the module. Limit for this voltage is mentioned in chapter 2.2 DC electrical specifications. User must take into consideration surge current and current consumption issues before using these pins. Also, the user must be aware for any voltage drop on the feeding path.

## **4.9 UART pins**

Pins 7, 8, 9, 10 are used for UART serial transmission between the module and the terminal. The UART signal level corresponds to the level in VCC\_IO pin. VCC\_IO pin must be fed with a correct voltage level to match the terminal device.

## **4.10 GPIO pins**

See separate document: TIL-0026\_SATEL-Radio-Modules\_GPIO-Interface.pdf

Unused pins should be left unconnected.

## 5 MECHANICAL CONSIDERATIONS

### 5.1 Fixing device to host

The radio module can be mounted on to the host application by using spacers and screws. It is highly recommended to use conducting metal spacers and screws to create proper electrical conductivity between the module and the host application. Recommended materials for spacers include brass or aluminum and steel screws. User must take care that there is no excessive mechanical stress created to the DTE connector while inserting and attaching the module. Recommended maximum screw size is M3 for the PCB, minimum spacer height between the module and the host application is 3 mm. Please contact SATEL or local SATEL distributor for heat sink piece models availability.

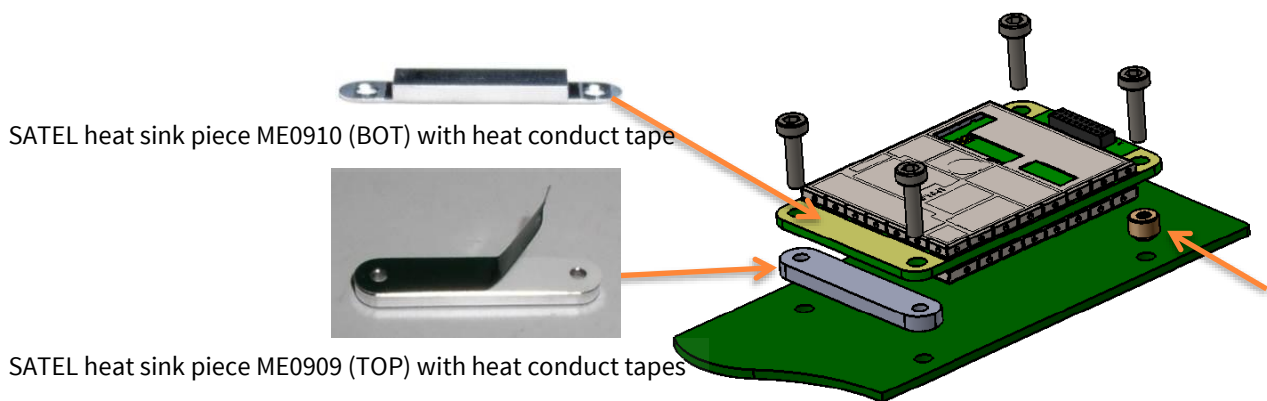
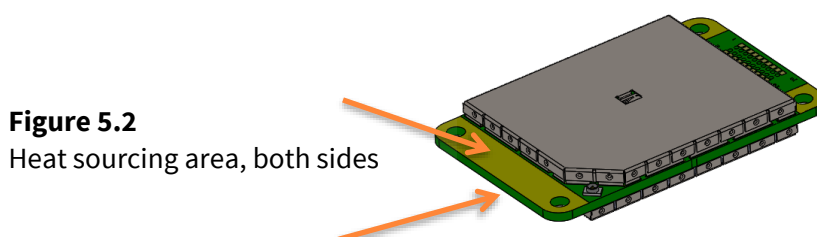

**Figure 5.1** Example of module attachment to application PCB.

Note! Firmware (depending on the specific version) self-protects the transmitter from overheating by disabling transmissions if the board temperature exceeds 96°C. After exceeding the limit, the module must cool down 10 degrees Celsius (to 86°C) to be able to transmit data to radio interface again. The board temperature can be checked by using SL commands (command “SL+C?PA”).

### 5.2 Heat transfer

Since the module creates heat while operating, it must be taken into consideration to maximize the heat transfer from the module to an external heat sink. Proper heat sinking methods could be copper plated PCB, metal housing or a heat sink piece. The most recommended solution is to use a metal conductor to transfer heat from the module to an external heat sink which dimensions and location is adequate for a proper performance. To source the heat from the module is the plain area next to the antenna connector shown in a figure 5.2. Heat can be conducted from either side. To further improve the heat conductivity and reducing the heat transfer barriers, proper heat conducting paste or heat conducting tape should be used.



**Figure 5.2**  
Heat sourcing area, both sides

## 6 OPERATING MODES

The radio transceiver module has the following modes of operation:

MODE	FUNCTION	DESCRIPTION
Ready to receive from RF	Search for sync	Module is searching for the start of a radio transmission from the RF signal.
	Receive data	The module has found a valid radio transmission and is receiving data.
TX	Transmit	The module transmits
Safe mode		Mode is entered when a fault has been detected and the device has been Rebooted. In safe mode fault codes can be read from the module (section 6.1).
Sleep mode	Sleep1	Will turn the module into a state where it will hold parts of the radio on, wakeup time see section 2.3
Power Save mode	Power save	Automatic sleep/wake-up procedure where module sleeping time is dynamically adjusted to received data packets. Decreases the power consumption of complete receiving cycle approx. 30%.

### 6.1 Safe mode

When a fault has been detected by the Firmware, the module is set to Safe mode. In this mode the module toggles the STAT pin in 250 ms interval indicating an Error and reboots the device after 5 s. Transmitting/Receiving is prohibited during malfunction. When connecting to the device with SATEL Configuration Manager the Error code is shown in pop up box. If the device does not recover after multiple reboots, please contact SATEL Oy.

SATEL Configuration Manager can be downloaded from website <https://www.satel.com/support-and-services/downloads/>.

### 6.2 Power up / power down scenarios

The transceiver module can be set in four (4) states, “ON”, “OFF”, “Sleep1” and “Power Save”. When power is applied to the module, the module switches to ON state when voltage in ENA\_MOD is set to HIGH.

The module can be shut down by driving ENA\_MOD line to LOW state. In the “OFF” state current consumption is only that of leakage current from an LDO, section 2.3. In this state all non-essential parts of the module are powered down and all settings/state information that are not stored in nonvolatile memory are reset.

### 6.3 Sleep Mode

When being in sleep mode, the radio part of the module is switched OFF while the serial interface communication related parts remain powered ON. The module will be automatically woken up after the CPU senses a state change in the TD1 pin. *Example:* The module is in Sleep1- mode. The module is woken up by sending a character or characters into the TD1 pin after which the module responds “OK”. After “OK” the module is ready for normal communication.

To turn the module ON from Sleep1 mode:

- 1) Issue a state change to TD1 (toggle pin (minimum pulse duration time 10  $\mu$ s) or issue a byte on the UART (for example 0x00))
- 2) Wait for “OK” -response from the module. The wake-up time is approx. 30 ms.
- 3) Start communicating normally

Module will remain powered ON until a new sleep command is issued.

### 6.4 Power Save Mode

The Power save mode performs an automatic, self-adjusting receiver wake-up/sleep cycle. It is designed for applications which base on one-way communication with relatively constant TX interval and, in which the data packet separation is > 200 ms.

When enabled, the unit makes the *transmission interval study* basing on four (4) successfully received data packets. The shortest time between transmitted packets is measured ( $t_{min}$ ). Measured value is updated after each successfully received data packet, so that possible changes in the message length become noted.

Ensuring that the complete messages will be received even if there occurs little variation in transmission interval, some safety margin ( $t_{marg}$ ) is left into Ready to receive from RF mode time.

Safety margin is calculated by dividing the shortest time between transmitted packets ( $t_{min}$ , in ms) with 8 and by adding 60 ms to this result:

$$t_{marg} = \frac{t_{min}}{8} + 60 \text{ ms}$$

The length of the whole sleeping period ( $t_{sleep}$ ) is calculated by decreasing the shortest time between transmitted packets ( $t_{min}$ ) with safety margin ( $t_{marg}$ ) and transmission time of the original message ( $t_{TX}$ ):

$$t_{sleep} = t_{min} - t_{marg} - t_{TX}$$

Transmission interval study is started over always after 100 successful sleep/wake-up cycles and, if the expected receiving slot ( $t_{RX\ slot}$ ) with enhanced overlap margin ( $t_{overlap}$ ) has been missed. In latter case the package is considered to be lost.

$$t_{overlap} = t_{marg} + 100\ ms$$

$$t_{RX\ slot,\ min} = t_{min} - t_{marg}$$

$$t_{RX\ slot,\ max} = t_{min} + t_{overlap}$$

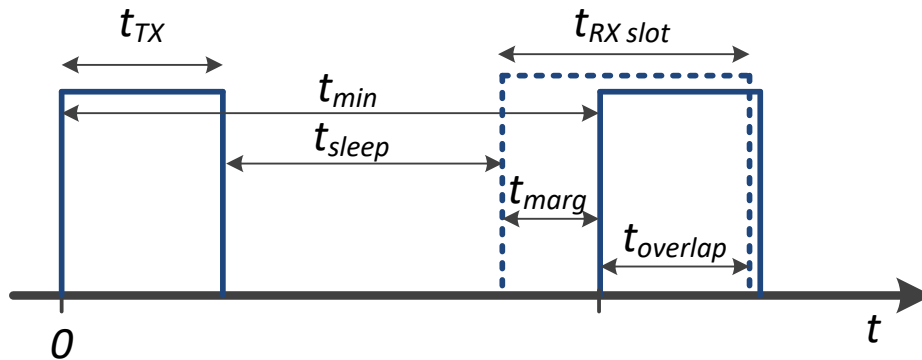

**Figure 6.1** Power save mode timing factors.

E.g. In system with TX interval of 1 s, and with 300 ms (approx. 300B @ 9600 bps) transmission time:

$$t_{min} = 1000\ ms$$

$$t_{TX} = 300\ ms$$

$$t_{marg} = 125\ ms + 60\ ms = 185\ ms$$

$$t_{sleep} = 1000\ ms - (125\ ms + 60\ ms) - 300\ ms = 515\ ms$$

$$t_{RX\ slot,\ min} = 1000\ ms - 185\ ms = 815\ ms$$

$$t_{RX\ slot,\ max} = 1000\ ms + 285\ ms = 1285\ ms$$

## 6.5 Restart

After startup the module can be restarted by issuing an SL command, upon which the module will shut down all circuitry, and Reboot the CPU (see SL command list).

## 7 CONFIGURATION

The configuration of settings can be changed easily - the next chapters describe the details:

### **SATEL SW tools**

Easy-to-use SATEL software tools suit most cases. Please see additional information in next chapters.

Please see additional information from SATEL WEB pages at:

<https://www.satel.com/products/software/>

Software can be download at: <https://www.satel.com/support-and-services/downloads/>

### **SL commands**

A terminal device can command or configure the radio modem by using special commands. SL commands are applied especially in cases where radio modems are to be integrated seamlessly inside a system behind the integrator's own user interface.

### **7.1 SATEL NETCO DEVICE software**

SATEL NETCO DEVICE is a software for configuring and reprogramming a SATEL device. The configuration parameters can be read and written from/to the locally connected, powered device. The device configuration can be also created/saved/explored from/to a file without device connection.

The most common use case for which the SATEL NETCO DEVICE is optimized for is editing existing parameters in a SATEL radio product using local connection, such as serial interface.

### **7.2 SATEL Configuration Manager software**

SATEL Configuration Manager is a software for configuring and reprogramming a SATEL device. The parameters can be read and written from/to the connected, powered device. The program file can be saved into a separate file to be used to other devices.

The most common use case for which the SATEL Configuration Manager is optimized for is editing existing parameters in a SATEL radio product using locally connected product over a serial interface. Minimum requirements: COM port with baud rate min. 9600 bps (alternatively with industrial level USB-RS-232 converter).

### **7.3 Changing parameters using SL commands**

The controlling terminal device can change the configuration settings of the module. This is accomplished with the help of SL commands. SL commands can be used to change e.g. the frequency or addresses. It is also possible to ask the radio transceiver module to show current settings which are in use.

### **7.3.1 SL Commands**

The controlling terminal device can change the configuration settings of a radio. This is accomplished with the help of SL commands, which can be used during data transfer. SL commands can be used to change e.g. the frequency or addresses. It is also possible to interrogate a radio modem to gain information concerning current settings that are in use. SL command -setting must be enabled before they can be used.

An SL command is a continuous string of characters, which is separated from other data by pauses which are equal or greater than time defined by Pause length parameter (default=3 characters) in the set-up. No extra characters are allowed at the end of an SL command.

Serial interface settings are the same as in data transfer. SL command is properly recognised also in the case when the command string is terminated by <CR> (=ASCII character no. 13, Carriage Return, 0x0d) or <CR><LF> (<LF> = ASCII char. no. 10, Line Feed, 0x0a). Pause according to set Pause Length -parameter is required also in this case. If multiple SL commands are sent to the module, the next command can be given after receiving the response ("Ok" or "Error") of the proceeding command. In addition, it is recommended to implement a timeout to the terminal software for recovering the case when no response is received from the radio module.

The transceiver module will acknowledge all commands by returning an "**OK**" (command carried out or accepted) or the requested value, or an "**ERROR**" (command not carried out or interpreted as erroneous) message. SL command response time depends on the command used. Typical response time is ~100ms and upwards. Recommended safe timeout for SL command response is 500ms.

SL Command -modes:

- ON (factory default)
  - SL commands are processed by the local radio
- OFF
  - SL commands can be operated only when "Command Mode" is set
- ON with CR/LF
  - SL commands are processed by the local radio, response include CR/LF
- OFF with CR/LF
  - SL commands can be operated only when "Command Mode" is set, response include CR/LF

It is possible to use SL commands in Port 2 (TD2 signal in GPIO3 (Pin13) and RD2 signal in GPIO1 (Pin11)) when Port2 Function has been configured as Diagnostics. SL commands can be used even in parallel with Port1 – in that case the response appears in the same port where the SL command came from.

Port2 is configured via SL commands or SW tools (SATEL NETCO DEVICE or SATEL Configuration Manager) by selecting the Port2 Function:

- OFF (=Port 2 not in use)
- Diagnostics (=SL commands ON in this case)

See Appendix 13.2 for SL commands. To get information of the latest and/or special SL commands please contact SATEL or local SATEL distributor:

<https://www.satel.com/where-to-buy/>.

### **7.3.2 Command Mode**

When the SL commands are enabled, there are possibilities that the user data may start with the characters “SL” which is handled as the SL command. This has caused the firmware to go to the continuous SL command search mode and any data has not been sent or even an “**ERROR**” acknowledgment has been received. To avoid this kind of behavior the user can disable the SL commands.

The SL commands can be disabled or enabled by using SL commands or toggling the “*SL Command mode*” parameter via SATEL SW tools, SATEL NETCO DEVICE or SATEL Configuration Manager (maintenance access level required).

By default, the *SL Command mode* is set to **ON**. If the *SL Command mode* is set to **OFF**, then the SL commands can be enabled or disabled by using the below described procedure. Regardless of the original SL command –setting state, changing the setting state with this procedure will affect the reception process of the radio module.

Radio can be set to *Command Mode* separately with “+++” command, regardless of the set SL command mode (ON/OFF). *Command mode* enables forcibly the SL command mode and disables the radio interface functions (Tx/Rx). By exiting from the Command Mode, user defined SL command parameter mode is restored, as well as radio interface functions.

To enable the *Command mode*:

- Send three “+” characters via serial port so that there is at least three bytes delay (according to Pause Length -setting) between each character. The response is “**OK**”, when successfully set.

<+><at least three bytes pause\*><+><at least three bytes pause\*><+>

To disable the *Command mode*:

- Send three “-” characters via serial port so that there is at least three bytes delay (according to Pause Length -setting) between each character. The response is “**OK**”, when successfully set.

<-><at least three bytes pause\*><-><at least three bytes pause\*><->

\*Pause Length -setting

Note!

The “+ + +” and “- - -” procedures are not recommended to be used when radio is transmitting or receiving data (i.e., the application data occupies the TD or RD lines of the radio).

## 8 SERIAL INTERFACE

The radio modem is referred to as DCE (Data Communication Equipment) whereas the device connected to it, typically a PLC or a PC, is referred to as DTE (Data Terminal Equipment).

To transfer data, the physical interface between DCE and DTE must be compatible and properly configured. This chapter describes shortly the basics of the physical interface options, the related settings and the operation of the serial interface.

Before connecting DTE (Data Terminal Equipment) to the radio modem, make sure that the configuration matches the physical interface (electrical characteristics, timing, direction and interpretation of signals).

### 8.1 Pause length

The modem recognises a pause on the serial line (a pause is defined as a time with no status changes on the UART interface TD-line). The pause detection is used as criteria for:

End of radio transmission - When the transmit buffer is empty and a pause is detected, the modem stops the transmission and will then change the radio to the receive mode.

SL command recognition - For a SL command to be valid, a pause must be detected before the actual command character string.

User address recognition - For the start character to be detected, a pause must precede it in transmission.

Traditionally, in asynchronous data communication, pauses have been used to separate serial messages from each other. However, the use of non-real-time operating systems (frequently used on PC-type hardware) often adds random pauses, which may result in the user data splitting into two or more separate radio transmissions. This may cause problems especially in the systems including repeater stations.

To match the operation of the radio modem to the user data, the Pause length parameter can be adjusted on the programming menu. It may have any value between 3 and 255 characters. The default value is 3 characters.

Notes:

The absolute time of Pause length is depending on the serial port settings. For example, 1 character is ~1.04 ms at 9600 bps / 8N1 (10 bits).

The maximum absolute time is always 170 ms independent from the value of the Pause length given in the set-up.

An increase in the Pause length increases the round-trip delay of the radio link correspondingly; this is because the radio channel is occupied for the time of the Pause length after each transmission (the time it takes to detect a pause). If this is not acceptable, the TX delay setting may also be useful in special cases.

## **8.2 Data buffering**

Whenever the radio modem is in *Data Transfer Mode* it monitors both the radio channel and the serial interface. When the terminal device starts data transmission the radio modem switches to transmission mode. At the beginning of each transmission a synchronisation signal is transmitted, and this signal is detected by another radio modem, which then switches into receive mode. During the transmission of the synchronisation signal the radio modem buffers data into its memory. Transmission ends when a pause is detected in the data sent by the terminal device, and after all buffered data has been transmitted. When the serial interface speed is the same or slower than the speed of the radio interface, the internal transmit buffer memory cannot overflow. However, when the serial interface speed exceeds the speed of the radio interface, data will eventually fill transmit buffer memory. In this instance, it will take a moment after the terminal device has stopped transmission of data for the radio modem to empty the buffer and before the transmitter switches off. The maximum size of transmit buffer memory is two kilobytes (2 kB). If the terminal device does not follow the status of the CTS-line and transmits too much data to the radio modem, the buffer will be emptied, and the transmission is restarted.

In the receive mode, the buffer works principally in the above-described way thus evening out differences in data transfer speeds. If the terminal device transmits data to a radio modem in receive mode, the data will go into transmit buffer memory. Transmission will start immediately when the radio channel is available.

## 9 RADIO PARAMETERS

This product offers the radio settings for user to select:

- Channel spacing: 25, 20 or 12.5 kHz
- Frequency can be any 6250 Hz divisible frequency with 12.5 and 25 kHz channel spacing options
- Frequency can be any 10000 Hz divisible frequency with 20 kHz channel spacing option

### 9.1 Transmitter

The output power of the transmitter is adjustable (see the table below for available values). The greatest allowable power depends on limits set by local authorities, which should not be exceeded under any circumstances. The output power of the transmitter should be set to the smallest possible level such that it still ensures error-free connection under variable conditions. Excessively high output power levels used in short link spans can cause interferences and affect the overall operation of the system.

Transmitter output power levels		
Output power (mW)	Output power (dBm)	403-473 MHz
10 mW	+10 dBm	✓
20 mW	~+13 dBm	✓
50 mW	~+17 dBm	✓
100 mW	+20 dBm	✓
200 mW	+23 dBm	✓
500 mW	+27 dBm	✓
1000 mW	+30 dBm	✓

The antenna (or a 50 Ohm attenuator) should be always connected to the antenna connector while the transmitter is being used to guarantee the maximum lifetime of the transmitter.

## 9.2 Receiver

The sensitivity of the receiver depends on the channel spacing of the radio modem, selected modulation level and on the mode of the FEC (error correction).

Radio modulation	Air rate bps @ 12.5 kHz	Sensitivity (BER 10E-2)
SATEL 4-FSK	9600	-112 dBm
SATEL 4-FSK*	7200*	-115 dBm*
SATEL 8-FSK	14400	-105 dBm
SATEL 8-FSK**	9600**	-112 dBm**
SATEL 16-FSK***	14400***	-104 dBm***
Radio Modulation	Air rate bps @ 25 kHz	Sensitivity (BER 10E-2)
SATEL 4-FSK	19200	-109 dBm
SATEL 4-FSK*	14400*	-113 dBm*
SATEL 8-FSK	28800	-103 dBm
SATEL 8-FSK**	19200**	-111 dBm**
SATEL 16-FSK***	28800***	-102 dBm***

\*Values apply with FEC ON, 3/4 coding

\*\*Values apply with FEC ON, 2/3 coding

\*\*\* Values apply with FEC ON, 3/4 coding always enabled

The radio modem measures the received signal strength (RSSI) of the receiver constantly. The Signal Threshold setting determines the received signal level above which the search for the radio messages is active. It is recommended that values given in the table above are used as a basis. If the threshold is set too low, it is possible that the receiver is trying to synchronise itself with noise. In such a case the actual data transmission might remain unnoticed. If the threshold is set too high, the weak data transmissions will be rejected although they could be otherwise receivable. Signal threshold should only be changed for a reason - for example in the following cases:

Continuous interference is present, and the desired signal is strong. In this case the signal threshold can be increased to prevent the modem from synchronising to the interfering signal(s) and /or possible noise.

Maximum sensitivity should be achieved, and the desired signal is very weak. In this case the sensitivity could increase by decreasing Signal threshold. This type of situation is usually a sign of a poorly constructed radio network / contact. Bit errors and momentary loss of signals can be expected in this kind of a situation. Some data might be successfully transferred.

The RSSI can be requested also locally by using a special SL command (SL@R?). The RSSI value is available 7s after the receiving the message.

Signal Threshold value range: -80 ... -118 dBm

Default value: -118 dBm

Note that the feature is OFF in case the value is -118 dBm.

## 9.3 Encryption

Data security is often a concern when using radio communication. In SATEL radio products, strong AES128/256-bit encryption (CTR-mode) on the air interface ensures privacy in the radio network. The principle of encryption in the radio path is to collect a certain amount of data to a shift register and manipulate it according to a certain rule. Every data packet is encrypted individually. The process of encryption adds 5 to 10 ms (depending on encryption mode) to each sent data packet (<5 characters in AES128 and <10 in AES256) and must be avoided in the cases where low latency is the most important requirement.

AES is open-source software from public domain. Author: Brian Gladman (U.K). The CTR-mode is SATEL's in-house implementation.

The product models that support the encryption for the RF interface can be viewed in SATEL WEB sites at [www.satel.com/products/](http://www.satel.com/products/). The radio models that do not support the encryption feature are compatible with the radio models with the encryption when the feature is disabled. The factory default value for the encryption feature is OFF state.

It is not possible to update/change the models NOT supporting the encryption to support this feature in the field. This task can be executed in SATEL factory premises and will be charged according to the service price list. The factory default value for the encryption feature is OFF state. The setting state with the static, distributed encryption keys must be set equally to the radios in the same radio network.

Please contact SATEL for more detailed information regarding the radio network compatibility settings in radio network between different models (channel width, radio frequency etc.).

The encryption password key is generated by using Main and Aux –keys + in the beginning of the data packet transferred changing 32/64-bit string. It is mandatory to insert both information keys with the mentioned length keys. Options for generating the encryption keys are:

- Manually via terminal connection:
  - o SL commands
- Automatically with password via SATEL NETCO DEVICE or SATEL Configuration Manager software (generates automatically the Main and Aux keys)

It is recommended to set up a radio network with encryption enabled by using only one selected configuration way. The password or the keys should be kept in a safe place as the keys can't be read from the device after configuration. The equivalency of the encryption keys between radio modems can be verified from the Key Hash –information field. Last 4 marks indicates the equivalency [0-9, A-F]. In case the password is forgotten, a new password will need to be set for all the radios of the network.

NOTE! This feature is designed for SATELLINE-3AS, SATEL-8FSK-1, SATEL-8FSK-2 and SATEL-16FSK-1 –radio compatibility modes.

## **9.4 Radio state**

This setting allows users to disable/enable the transmitter. Unless overridden by the factory configuration, users can select state of the radio by using SATEL NETCO DEVICE or SATEL Configuration Manager software and selecting the value Enabled Radio States:

- Tx/Rx (both transmitter and receiver are enabled)
- Rx Only (transmitter out of use, receiver enabled)

In case the factory configuration defines the modem as Rx-only device, the value can't be changed by the users.

NOTE! Rx Only device replies "0mW" to SL@P? (Get transmitter power) command.

## **9.5 Priority RX/TX**

Priority setting selects the priority between reception and transmission. The setting can be changed either via SL commands or SW tools (SATEL NETCO DEVICE or SATEL Configuration Manager). By default, transmission has higher priority than reception i.e., the default value is Priority TX.

Priority TX means that the device attached to a radio modem decides the timing of the transmission. The transmitter is immediately switched on when the terminal device starts to output data. Should reception be in progress, the radio modem will stop it and change to a transmit state. There is no need to use any handshaking for the control of timing.

Priority RX means, that a radio tries to receive all data currently in the air. If a terminal device outputs data to be transmitted (or an SL command) it will be buffered. The radio modem will wait until the reception has stopped before transmitting the buffered data. This will result in timing slacks to the system but decreases the number of collisions on the air; this is particularly useful in systems based on multiple random accesses.

## **9.6 Forward Error Correction (FEC)**

FEC improves the reliability of data transfer over the radio by adding additional correction information to the radio messages. Based on that information, the receiving radio modem will be able to correct erroneous bits provided the ratio of erroneous and correct bits is reasonable. However, the use of FEC decreases the data throughput because the amount of transmitted data increases about 30 %. FEC should be used on long distance links and/or if the radio channel is "noisy" in other words suffering from interfering signals.

**NOTE!** All radio modems, which are to communicate with each other, must have the same setting for FEC (ON or OFF). If the transmitting radio modem and the receiving radio modem has different settings, data will not be received.

## **9.7 Error checking**

When the error checking is switched on, the radio will add a checksum to the transmitted data. When the data is received, the checksum is verified before data is forwarded to the serial port. Options for error checking can be accessed either via SL commands or SW tools (SATEL NETCO DEVICE or SATEL Configuration Manager). Error Check modes:

*OFF (default setting).* Received data is not verified at all. In practice, this is the fastest way to operate, because the data is given out from serial port immediately after it has been received. This is recommended method if the application protocol already includes error checking functions.

*CRC-16 Full* adds checksum characters accordingly at the end of the user data message. At the reception end the receiver receives first the whole package and if the checksum matches the data message is forwarded to the serial port. It is possible include the checksum into the received data in the serial line by setting the CRC-16 Full check to OFF state at the receiving radio(s). Additional data transfer delay will be added approximately according to the data packet size to the total transfer delay.

NOTE! This feature is designed for SATELLINE-3AS, SATEL-8FSK-1, SATEL-8FSK-2 and SATEL-16FSK-1 –radio compatibility modes.

## **9.8 TX Delay**

The transceiver can be configured to delay the beginning of a radio transmission by 1...65000 ms. The function can be used to prevent packet contention in a system, where all substations would otherwise answer a poll of a base-station simultaneously. During this delay data sent to the radio modem is buffered. Even when the priority setting is "RX", the radio modem is prevented to change over to the receiving mode during the period of the TX delay. If TX delay is not needed, its value should be set to 0 ms.

## **9.9 Add RSSI to data**

RSSI info "\02RSSI:-nnn dBm\03\0D\0A" will be concatenated to the end of serial port messages, nnn is three digit decimal number.

## **9.10 Separate TX/RX frequencies**

Modem can transmit (TX-frequency) and receive (RX-frequency) on separate frequencies. The switch between the frequencies introduces an extra 20 ms delay in the data transfer that must be taken account when designing the system.

## 9.11 User data whitening

In some cases, if the user data includes a large number of constant characters, additional bit errors may appear. The use of error correction (FEC) is recommended in such cases. If that is not possible, the Data whitening feature can be used to improve the reliability of data transfer. The parameter can be adjusted via SL commands, "SL%W=n". Value of n: 0 = OFF, 1 = ON. "SL%W?" = Get data whitening.

**NOTE!**

All radio modems, which are to communicate with each other, must have the same setting for Data whitening (ON or OFF). If the transmitting radio modem and the receiving radio modem has different settings, data will not be received correctly.

NOTE! This feature is designed for SATELLINE-3AS, SATEL-8FSK-1, SATEL-8FSK-2 and SATEL-16FSK-1 –radio compatibility modes.

## 9.12 Call Sign

Call sign means that the modem transmits its Call sign ID periodically using Morse keying. Call sign is configured using three settings:

- a) Call sign mode sets Call sign operation ON/OFF.
- b) Call sign ID defines Morse code to be transmitted, max. sixteen characters, capital letters and numbers are allowed (lower case letters are converted automatically to uppercase letters).

If Call sign mode is not used (OFF) you can enter e.g. "CALLSIGN" for the Call sign ID.

- c) Call sign timer is the interval (1...30 min) between Call sign transmissions.

One Call sign transmission may take several seconds to transmit, depending on the Call sign ID.

Default value: Call sign mode OFF

## 9.13 Channel list

A list of predefined radio channels can be stored in the memory in order to change the radio settings simply by switching between the channels. Each channel carries the following info:

- Channel number (any number -32767...32767)
- Transmitter/Receiver frequency
- Channel width (12.5, 20 or 25 kHz)
- Transmitter power level (optional)

Additionally, the default channel that the radio modem uses after a reset is defined.

When TX frequency of the active channel is set to 0, the radio modem operates as receive-only device (in case the value of Rx frequency is valid).

Channel lists can be created and utilized by using either SATEL NETCO DEVICE or SATEL Configuration Manager software tools or SL commands. Software tools provide a channel list

editor (snapshots below) for creating and saving a channel list in the radio modem, or in a file for later usage.

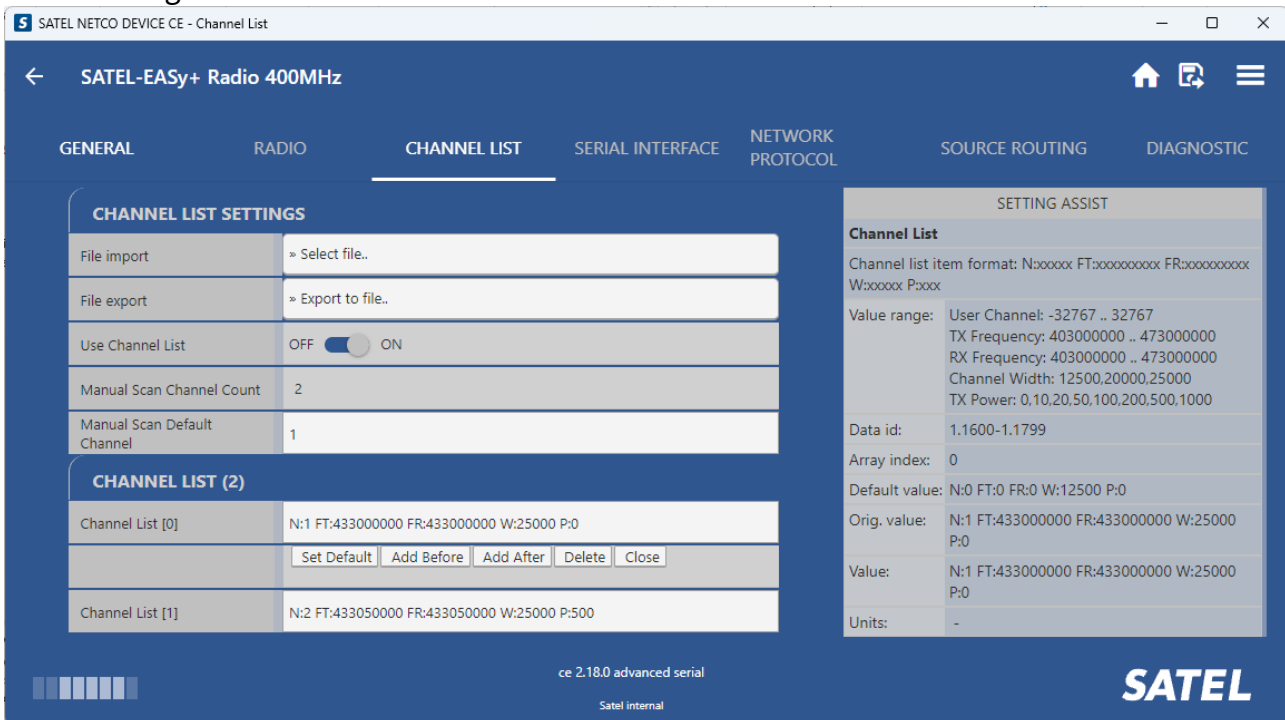

SATEL NETCO DEVICE.

Index	User Channel	TX Frequency	RX Frequency	Channel Width	Tx Power
0	0	430000000	430000000	12500	1000
1	1	431000000	431000000	12500	1000
2	2	432000000	432000000	12500	1000

SATEL Configuration Manager.

Entering the Channel List -feature parameters require elevated access level to software tools.

SL commands provide an interface for a host device to command the radio modem directly. An example of the procedure for creating or replacing a channel list:

1. Clear existing channel list (SL\$C=0)
2. Set channel info for each of the channels to be created starting from index 0 (SL\$L=)
3. Set number of channels in channel list (SL\$C=)
4. Set the default channel (SL\$D=)
5. Verify the new configuration:
  - Get number of channels in channel list (SL\$C?)
  - Get channel info for each of the channels (SL\$L?)
  - Get the default channel (SL\$C?)
7. Enable Channel list (SL\$M=1) in order to activate the Channel list
8. Save the settings (SL\*\*>)

## **9.14 Repeater –mode**

Repeaters and addressing may be used to extend the coverage area of a radio modem network, and to direct messages to selected radio modems in the network. In large systems, with several repeaters and formed repeater chains, it is often practical to use routing instead of plain addresses.

In circumstances where it is necessary to extend the coverage area of a radio modem network, modem can be used as repeater stations.

The maximum size of a repeated data packet is 2 kB (two kilobytes). The Repeater Function is switched on in the radio settings. In the repeater mode the radio modem will function as a totally independent unit. Other devices are not necessary.

A radio modem acting as a repeater can also be used to receive and transmit data. In repeater mode the radio modem will transmit the received data to the serial interface in a normal fashion. The difference being that the received data will be buffered into the buffer memory. After reception the radio modem will re-transmit the buffered data using the same radio channel as in reception. Data received through the serial interface a radio modem in repeater mode will transmit normally.

The same network may include several repeaters, which operate under the same base station. Repeaters may also be chained; in which case a message is transmitted through several repeaters. In systems with more than one serially or parallelly chained repeater, addressing or routing protocol must be used to prevent a message ending up in a loop formed by repeaters, and to ensure that the message finally reaches only the intended radio modem.

Please contact SATEL for more information of Repeater- and Addressing –features.

## **9.15 Radio compatibility**

SATEL provides several radio compatibility modes:

- for selecting the optimum radio solution that fits the application
- for enabling the interoperability between devices made by different manufacturers

SATEL-TR4+ supports the original SATEL radio compatibility modes:

- SATELLINE-3AS (4FSK, FEC ON/OFF is selected by the separate FEC setting) (option 0)
- SATEL-8FSK-1 (8FSK/FEC OFF) (option 20)
- SATEL-8FSK-2 (8FSK/FEC ON) (option 21)
- SATEL-16FSK-1 (16FSK/FEC ON) (option 22)
- SATELLINE-2ASxE legacy mode (option 6)

Additional to the native SATEL radio compatibility modes, also the following radio compatibility modes are supported by the 403 - 473 MHz frequency band.

- Pacific Crest compatible modes:
  - PacCrest-4FSK FEC ON/Scrambling ON (option 1)
  - PacCrest-4FSK FEC OFF/Scrambling ON (option 23)
  - PacCrest-4FSK FEC OFF/Scrambling OFF (option 26)
  - PacCrest-4FSK FEC ON/Scrambling OFF (option 28)
  - PacCrest-GMSK FEC ON/Scrambling ON (option 2)
  - PacCrest-GMSK FEC OFF/Scrambling ON (option 24)
  - PacCrest-GMSK FEC OFF/Scrambling OFF (option 27)
  - PacCrest-GMSK FEC ON/Scrambling OFF (option 29)
  - PacCrest-FST 4FSK/FEC ON (option 5)
  - PacCrest-FST 4FSK/FEC OFF (option 25)
  - PacCrest-GMSK FEC ON, Scrambling ON, 4800 bps, 25 kHz (option 16)
  - PacCrest-GMSK FEC OFF, Scrambling ON, 4800 bps, 25 kHz (option 17)
  - PacCrest-GMSK FEC OFF, Scrambler OFF, 4800 bps, 25 kHz (option 18)
  - PacCrest-GMSK FEC ON, Scrambler OFF, 4800 bps, 25 kHz (option 19)
- Trimble compatible modes:
  - TrimTalk450s(P) GMSK, Rx fitted to PacCrest transmitters (option 3)
  - TrimTalk450s(T) GMSK, Rx fitted to Trimble transmitters (option 4)
  - TrimTalk v1, GMSK, 8/16 kbps (option 30)
  - TrimTalk 4800 bps, 25 kHz (option 31)
  - Trimmark3 (option 12)
- SOUTH (option 8)
- RTCM SC135 modes – these are based on RTCM (Radio Technical Commission for Maritime Services) standard 13500.1 on Radio Layer for Real-Time DGNS Applications.
  - RTCM SC135 1 (25 kHz, FEC ON) (option 34)
  - RTCM SC135 2 (12.5 kHz, FEC ON) (option 35)
  - RTCM SC135 3 (25 kHz, FEC OFF) (option 36)
  - RTCM SC135 4 (12.5 kHz FEC OFF) (option 37)

Notes:

- Supported compatibility options may vary depending on the model and factory configuration.
- All radio modems of a system must have identical FEC (ON or OFF) and Scrambling (ON or OFF) settings.
- The implementation of the non-native radio compatibility options is based on the reference measurements and the available public data of the following radio modems manufactured by Pacific Crest Corporation: ADL, RFM96W, PDL HPB, PDL LPB.
- TRIMTALK is a trademark of Trimble Navigation Ltd.
- SOUTH is a trademark of SOUTH Surveying & Mapping Instrument Co., Ltd.

The wanted radio compatibility mode can be selected by using:

- LCD UI (if equipped with such)
- SATEL SW tools
- SL command SL@S (see chapter *SL commands*)

### **9.15.1 Settings in Pacific Crest/TRIMTALK compatibility modes**

In order to use the Pacific Crest/TRIMTALK modes implemented in SATEL/SATELLINE radios:

PACIFIC CREST modems must have:

- Protocol Mode
- Transparent w/EOT Timeout (when using Pacific Crest modulations)
- TrimTalk 450s (when using TRIMTALK GMSK modulation)
- Modulation Type depends on the system
- GMSK (default, always selected when using TRIMTALK 450s mode)
- 4-Level-FSK
- FEC = ON/OFF
- Scrambling = ON/OFF
- Data Security Code set to = 0 (=not used)
- Local Address= 0...254 (0 by default)

Pacific Crest modems receive messages from SATELLINE modems that have their TX1 address matching the Local Address.

Remote address=0...255 (255 by default, that is the broadcast address to be received by all).

SATELLINE modems receive the message from a Pacific Crest radio, provided their RX1 address matches the Remote Address of a Pacific Crest transmitter (or if the message has the broadcast address 255).

SATELLINE modems must have the following key settings:

- FEC OFF (because the FEC here means SATEL 3AS FEC, not Pacific Crest/TRIMTALK FEC)
- Error check OFF
- Error Check mode OFF
- Radio Compatibility Option according to the list (setting dependent)

When TX address is selected ON, then TX1 address is used like PDL Remote address that is the destination address for the transmitted messages. Default value is 0x00FF (=255) (note the hexadecimal format of the setting).

When RX Address is selected ON, then RX1 address is used like PDL Local address. Default value is 0x0000 (=0) (note the hexadecimal format of the setting).

Addresses are NOT applicable in TRIMTALK 450s mode so SATELLINE modems must have their RX/TX addresses OFF with Option3.

The configuration tools and settings are different between SATELLINE and Pacific Crest modems: Pacific Crest modems are configured via the serial port using PDLCONF Windows™ program that sends binary control messages to the serial port of the modem. SATEL radio modems are configured via the serial port using SATEL SW tools or SL commands.

The table below shows the analogy of settings between Pacific Crest and SATELLINE radio modems.

<b>Pacific Crest setting</b>	<b>Corresponding SATELLINE setting</b>
Identification: Owner	not implemented
Identification: Channel Bandwidth	Channel spacing
Identification: RF Power	TX power
Radio Link: Channel Selection Type (Manual)	Radio frequency
Radio Link: Current Channel	Radio frequency
Radio Link: Link Rate	Radio compatibility mode and channel spacing determine the link rate
Radio Link: Modulation Mode	Radio compatibility
Radio Link: Scrambling	ON by default
Radio Link: Transmit Retries	not implemented
Radio Link: TX ACK Timeout	not implemented
Radio Link: Csma Monitoring	Priority (RX=ON, TX=OFF) Default: TX
Radio Link: AutoBase/AutoRover	not implemented
Radio Link: Digisquelch	Signal threshold
Radio Link: Forward Error Correction	ON by default Note: SATELLINE-EASy FEC must be OFF!
Radio Link: Local Address (0 by default)	Primary RX address (RX1) (OFF by default)
Radio Link: Remote Address (255 by default)	Primary TX address (TX1) (OFF by default)
Serial Interface: Protocol Mode	Radio compatibility
Serial Interface: BREAK to Command	not implemented
Serial Interface: Modem Enable: Yes	not applicable
Serial Interface: Soft Break Enable	not implemented
Serial Interface: EOT value (in 0.01s units)	Pause length (in serial port byte intervals)
Serial Interface: Digipeater Delay	not implemented
Serial Interface: Local Node Repeater	not implemented
Frequency Table	Radio frequency
Data Security Code (must be 0=not used)	not implemented
<p>Potential conflicts:            FEC setting applies only to the SATELLINE-3AS mode, the other radio compatibility modes have their own FEC bindings (although some previous or special firmware versions differ in the way FEC setting is handled - in case of doubt please contact technical support)            Error check and Full CRC16 check must be OFF in SATEL/SATELLINE modem            SATELLINE RX/TX addressing does not use ARQ scheme like Pacific Crest radios.</p>	

### **9.15.2 Repeater function**

The implemented Pacific Crest/TRIMTALK modes support also the repeater function. The repeater function is configured either by using the SL commands:

- "SL@M=R" (Repeater ON)
- "SL@M=O" (Repeater OFF)

or by selecting Repeater OFF/ON in the SW tools (SATEL NETCO DEVICE or SATEL Configuration Manager).

Note 1. If error correction is ON (FEC ON) and TRIMTALK mode is activated by using "SL@S=3" command, the firmware automatically switches SATEL FEC OFF temporarily, and turns it back at the mode return.

### **9.15.3 Support for Local / Remote addresses**

If the modem has TX address ON then primary TX address is handled in the same way as Remote address in Pacific Crest PDL modems. The default value is 0x00FF (255 in decimal format) i.e. the broadcast address.

If the modem has RX address ON then primary RX address is handled in the same way as PDL Local address in Pacific Crest PDL modems. The default value is 0x0000 (0 in decimal format). SATELLINE modem needs to have TX Delay 50ms or more in order to avoid messages from colliding in case it is to be placed in a Pacific Crest system that uses addressing and acknowledging scheme.

In case only broadcast messages are used (like in RTK applications) there is usually no need for TX Delay, except if the transfer delays identical to Pacific Crest modems are preferred – in such cases an appropriate value of TX Delay is 34 ms.

Note 1. SATELLINE-modems do not support Pacific Crest retransmit/acknowledge scheme. However, that has no effect in RTK applications because they utilize only broadcast messages.

### 9.15.4 Transmission delays

The original SATELLINE-3AS is the fastest mode. In the PacCrest-4FSK, PacCrest-GMSK and Trimtalk450s modes the whole message is first read from the serial port. Thus the actual raw data rate is appr. 2/3 of the symbol rate. The end of the message is detected when there is a pause in data. After that data is framed and transmitted over the radio. Likewise the reception is done fully before outputting the message to the serial port.

Channel Bandwidth →	12.5 kHz					25 kHz					
Air Interface Speed/bps Compatibility Mode	4800	7200	8000	9600	14400	4800	9600	14400	16000	19200	28800
SATELLINE-3AS FEC OFF				X						X	
SATELLINE-3AS FEC ON		X						X			
SATEL-8FSK-1 (FEC OFF)					X						X
SATEL-8FSK-2 (FEC ON)				X						X	
SATEL-16FSK-1 (FEC ON)					X						X
TrimTalk450s (options 3&4)	X						X				
TrimTalk 4800 (option 31)						X					
TrimTalk V1 (option 30)			X						X		
Trimmark3 (option 12)				X						X	
PacCrest-GMSK	X					X	X				
PacCrest-FST (4FSK)				X						X	
PacCrest-4FSK				X						X	
RTCM SC135 (FEC OFF)				X						X	

The typical latency vs. the size of a message is shown in the tables below for each radio compatibility mode. The delays are measured from the end of transmitted data to the end of received data on the serial interface.

Pacific Crest 4FSK mode on 12.5 kHz channel - Transfer delays				
Bps	1 byte	10 bytes	100 bytes	500 bytes
9600	74 ms	82 ms	302 ms	1293 ms
19200	73 ms	77 ms	249 ms	1031 ms
38400	72 ms	74 ms	222 ms	900 ms

Pacific Crest 4FSK mode on 25 kHz channel - Transfer delays				
Bps	1 byte	10 bytes	100 bytes	500 bytes
9600	43 ms	51 ms	208 ms	911 ms
19200	41 ms	46 ms	155 ms	650 ms
38400	39 ms	43 ms	127 ms	519 ms

<b>Pacific Crest GMSK mode on 12.5 kHz channel - Transfer delays</b>				
Bps	1 byte	10 bytes	100 bytes	500 bytes
9600	93 ms	101 ms	445 ms	2011 ms
19200	91 ms	97 ms	393 ms	1750 ms
38400	91 ms	92 ms	366 ms	1619 ms

<b>Pacific Crest GMSK mode on 25 kHz channel - Transfer delays</b>				
Bps	1 byte	10 bytes	100 bytes	500 bytes
9600	52 ms	62 ms	281 ms	1272 ms
19200	50 ms	55 ms	226 ms	1009 ms
38400	48 ms	51 ms	198 ms	878 ms

<b>Trimtalk450s modes on 12.5 kHz channel - Transfer delays</b>				
Bps	1 byte	10 bytes	100 bytes	500 bytes
9600	153 ms	177 ms	421 ms	1505 ms
19200	151 ms	172 ms	368 ms	1244 ms
38400	151 ms	168 ms	341 ms	1113 ms

<b>Trimtalk450s modes on 25 kHz channel - Transfer delays</b>				
Bps	1 byte	10 bytes	100 bytes	500 bytes
9600	82 ms	98 ms	267 ms	1017 ms
19200	80 ms	93 ms	215 ms	756 ms
38400	79 ms	89 ms	187 ms	625 ms

<b>Radio compatibility Option 5 - Pacific Crest FST on 12.5 kHz channel</b>				
Bps	1 byte	10 bytes	100 bytes	500 bytes
9600	47 ms	71 ms	261 ms	1145 ms
19200	45 ms	64 ms	207 ms	883 ms
38400	48 ms	65 ms	184 ms	756 ms

<b>Radio compatibility Option 5 - Pacific Crest FST on 25 kHz channel</b>				
Bps	1 byte	10 bytes	100 bytes	500 bytes
9600	31 ms	48 ms	190 ms	840 ms
19200	29 ms	41 ms	136 ms	578 ms
38400	28 ms	38 ms	109 ms	447 ms

## 10 TEST MODES

The radio modem can be switched to a Test Mode in which it will send test messages to the radio channel. Test messages can be utilized for example when directing antennas during system installation. The transmitting radio modem needs only a power supply and an antenna in the test mode but no external terminal device. If the test mode has been set ON, the radio modem starts to transmit test messages immediately after a reset or a power-up. Test messages are treated as normal data at the receiver side.

### 10.1 Short Block Test

In this test mode the radio modem sends a short test message that is preceded by a consecutive number and terminated by the Carriage Return and Line Feed characters. The test messages are repeated continuously at 1 second intervals. The short block test is suitable for running radio link tests. Reception of data can be monitored using a suitable terminal program.

#### Example of short data blocks:

```
00 This is a testline of SATELLINE-3AS radio modem  
01 This is a testline of SATELLINE-3AS radio modem
```

### 10.2 Long Block Test

In this test mode the radio modem transmits a test message continuously for 50 s. After 10 s break the test transmission is started again. The transmission sequence is repeated continuously. The long block test can be used to measure the transmitter output power, standing wave ratio (SWR) of the antenna system or RSSI (Received Signal Strength Indicator) level at the receiver stations. RSSI can be monitored easily on the LCD display of the receiving modem or by using SL command "SL@R?".

#### Example of a long data blocks:

```
99 This is a long testline of SATELLINE-3AS radio modem  
00 This is a long testline of SATELLINE-3AS radio modem
```

Note1. Remember to set the test mode OFF before starting the normal data transfer.  
Note2. The Test -modes are designed to be used in "SATELLINE-3AS" compatibility mode.

## 11 DEFAULT DELIVERY VALUES

<b>DEFAULT VALUES OF THE USER ADJUSTABLE SETTINGS</b>		
<b>Setting</b>	<b>Default value</b>	<b>Range</b>
Radio frequency		
Operating TX and RX frequency	<b>438.000 MHz</b>	<b>403 - 473 MHz</b>
Channel Spacing (equals channel width)	<b>12.5 kHz</b>	<b>12.5, 20 (uses 12.5kHz channel width), 25 kHz</b>
Transmitter Output Power	<b>1 W</b>	<b>0.01, 0.02, 0.05, 0.1, 0.2, 0.5 and 1 W</b>
Radio settings		
Radio Compatibility	<b>SATELLINE-3AS</b>	SATELLINE-3AS PacCrest-4FSK PacCrest-GMSK PacCrest-FST TrimTalk450s(P) TrimTalk450s(T) Trimtalk / Trimtalk v1 Trimmark3 SATELLINE-2ASxE (Ask availability from SATEL) SATEL-8FSK-1 (FEC OFF) SATEL-8FSK-2 (FEC ON) SATEL-16FSK-1 (FEC ON) RTCM SC135 1 25 kHz FEC ON RTCM SC135 2 12.5 kHz FEC ON RTCM SC135 3 25 kHz FEC OFF RTCM SC135 4 12.5 kHz FEC OFF
Addressing		
RX Address	<b>OFF</b>	<b>ON/OFF</b>
TX Address	<b>OFF</b>	<b>ON/OFF</b>
Serial port		
Data speed	<b>115200 bps</b>	<b>9600 -115200 bps</b>
Data bits	<b>8</b>	<b>8</b>
Parity bits	<b>None</b>	<b>None, Even, Odd</b>
Stop bits	<b>1</b>	<b>1</b>
Handshaking		<b>Handshaking lines apply to the DATA-port</b>
CTS	<b>TX Buffer State</b>	<b>Clear to send, TX Buffer State</b>
RTS	<b>Ignored</b>	<b>Ignored, Flow Control</b>
Additional setup		
Error Correction, FEC	<b>OFF</b>	<b>ON/OFF</b>
Error check	<b>OFF</b>	<b>OFF, CRC16Full</b>
SL Command Mode	<b>ON</b>	<b>ON/OFF</b>
Repeater Mode	<b>OFF</b>	<b>ON/OFF</b>
TX Delay	<b>0</b>	<b>0 .... 65535 ms</b>
Over-the-Air-Encryption	<b>OFF</b>	<b>ON/OFF</b>
Use Channel List	<b>OFF</b>	<b>ON/OFF</b>
Power Save Mode	<b>OFF</b>	<b>ON/OFF</b>
Add RSSI to Data	<b>OFF</b>	<b>ON/OFF</b>
Radio state	<b>Tx/Rx</b>	<b>Tx/Rx / Rx (transceiver modules)</b>
Priority	<b>Tx</b>	<b>Tx/Rx</b>
Signal Threshold	<b>-118</b>	<b>-80 ... -118 dBm</b>

## 12 CONSIDERATIONS

### 12.1 EMI Interferers

The module is designed to be mounted inside a host device. The module is designed to withstand EMI even beyond type approval requirements. However, a small module which is integrated closely to modern high-speed electronics is bound to receive some interference.

To make a working integration, consider the following: EMI can enter the module in four ways:

- 1) Via the antenna (radiation from enclosure enters the antenna)
- 2) Radiated disturbances to the coaxial cable
- 3) Radiation from other electronics / cabling directly to the module
- 4) Conducting through the DTE interface (power, control and data lines).

Because the module is shielded and the DTE interface is filtered, the usually worst method of disturbance is via the antenna port, which is easily overlooked in design. Keep in mind that the radio module has a sensitivity of approx. -115 dBm (depends on mode of operation and speed etc.). While the module has an approx. 10 dB S/N requirement, this constitutes, that any signal entering the radio antenna on receive frequency on a level of < -125 dBm (-115 dBm -10 dB), causes desensitization of the radio on that particular channel.

Example:

An interferer has a level of -100 dBm on the frequency 421 MHz. The radio will show an approximate sensitivity of -90 dB (-100 dBm+S/N requirement 10 dB) on 421 MHz.

Now consider that generic EMC requirements usually have pass/fail criteria of -57 dBm (if normalized to the surface of the device). **So there is almost a 70 dB gap between generic EMC requirements and co-existence requirements between a high sensitivity narrowband radios.**

To avoid problems of co-existence a good design should apply:

- 1) EMI shielding in enclosure – ambient air interface
- 2) careful layout
- 3) shielding of all digital high-speed parts and cables
- 4) Have a clocking plan to avoid clock frequencies causing harmonics on the UHF band of interest.

Number one is to recognize this challenge and act upon it.

SATEL R&D can help in this by participating in design review of the host device, aiming to catch problems early in the design phase.

## **12.2 Electrostatic discharge**

As the module is intended to be embedded in a host application, in a typical use case, the antenna port is the only port of the module directly interface with a surface or contact area subjected to Electrostatic Discharge (ESD). Thus, the antenna port is the only interface with high level ESD protection. The DTE port also features ESD protection diodes, but is not designed to withstand similar performance as expected from standalone units with enclosures.

Consequently, the module should be subject to ESD handling precautions that typically apply to ESD sensitive components. Proper ESD handling and packaging procedures must be applied throughout the processing, handling and operation of any application that incorporates this module.

## **12.3 Using the device in unmanned high reliability applications**

The module features software and hardware watchdogs which are incorporated inside the CPU. While we believe that this is a reliable method of keeping the module in operational condition, there are parts of the module that can't be monitored for proper operation to 100%. For example the module chip has a firmware that resides in the chips RAM. The firmware can't be read back or reloaded, without interrupting reception. Hence the module can't reload this automatically by itself without causing breaks in communication. To avoid the module from ending up in a state where for example the module chip firmware is corrupted for example by ionizing radiation, it is recommended that the controlling system implements some form of watchdog function for the module. This can be done for example if the system knows that data should be received every second, and no data has been received for a minute – then do a module restart using the ENA\_MOD pin or by issuing a restart command, or a cold boot by toggling VCC\_IN low and high again.

## **12.4 Proposals for more reliable radio link**

In case where the environment is challenging the following methods can be used for improving the transmission reliability:

- Forward Error Correction, FEC, is recommended to use in challenging environment like urban areas.
- Directional antennas.
- Before building the radio link(s) it is highly recommend that the radio environment is measured to find out whether the radio environment is clean enough by using a spectrum analyzer or radio module's RSSI, Received Signal Strength Indication, value.
- Co-operation with the local authority to find out the optimum free radio channel.
  - If the channel is disturbed an external band-pass filter can be used for improving the filtering.
  - If at the adjacent channel is TDMA, Time Domain Multiple Access, it is recommended to use time slot for receiving which is not in synchronization with the TDMA radio transmission.
  - In Europe it is not recommended to use channels which are located near by the TETRA or television frequencies.

# 13 APPENDIX

## 13.1 Module dimensions

In figure below is SATEL-R4+ and SATEL-TR4+ with dimensions as millimeters.

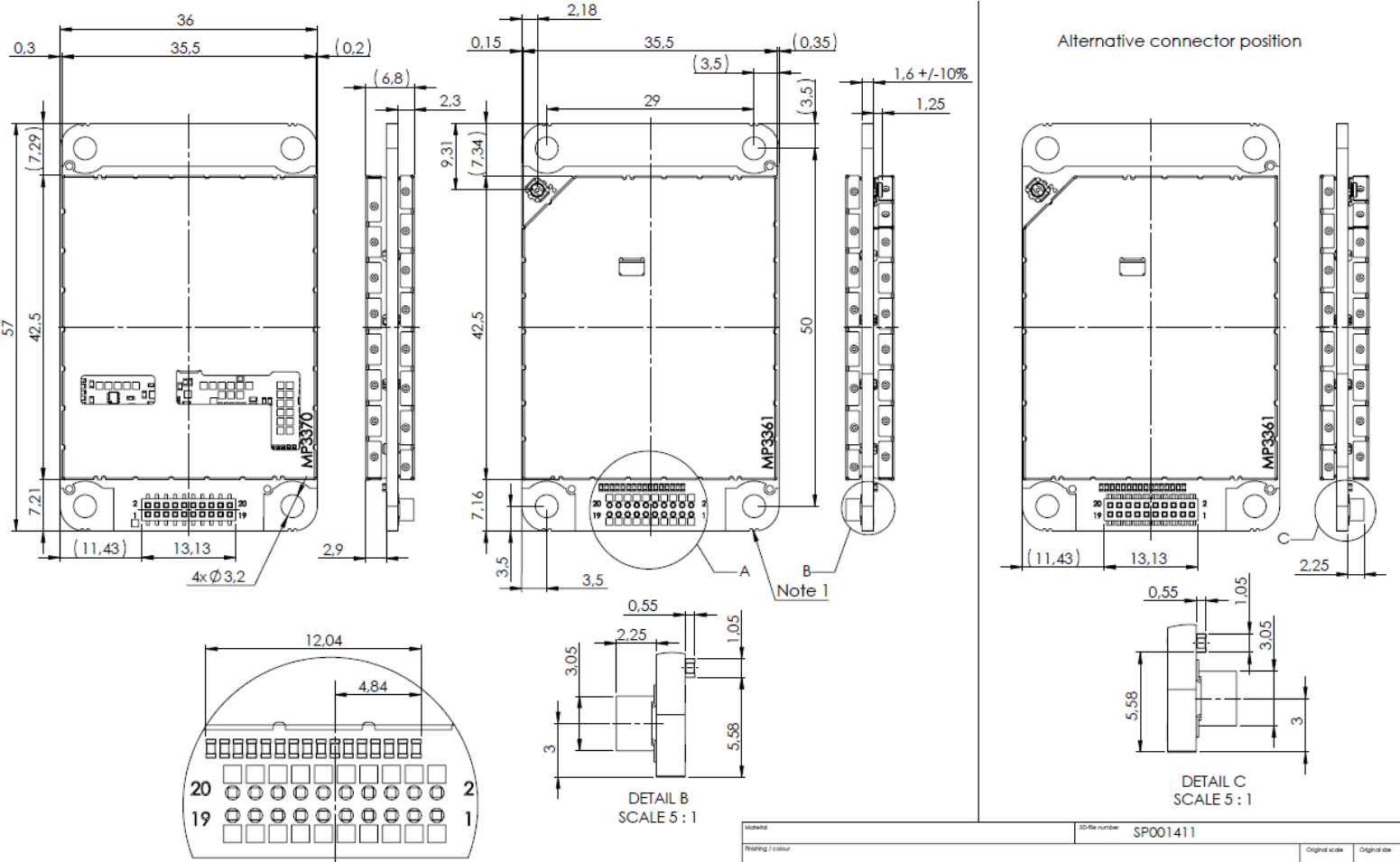

Note 1:  
Each cut bridge (4 pcs) may extend board length 0.5mm

Title		3D file number		SP001411	
Drawing / colour		3D designer		Original scale	
3D designer date		3D designer date		Original date	
IKo / 15.9.2020		IKo / 15.9.2020		2:1	
Description		3D Rev.		A3	
SATEL-TR4+		20.00		1	
Document number		Project		3D Rev.	
SP001411		P0009		2.00	
Copyright SATEL Oy.		3D Rev.		2.00	
This drawing contains proprietary and confidential information.		3D code		1 / 1	
Unauthorized reproduction of this drawing is not permitted.		Sheet		1 / 1	

## 13.2 SL commands

Category	Command	Description	Response
Addressing	SL#A?	Show all addresses (RX1, RX2, TX1, TX2)	"xxxx,yyyy,zzzz,vvvv"
Addressing	SL#A=xxxx, yyyy, zzzz,vvvv	Set RX/TX addresses (RX1, RX2, TX1, TX2)	"OK" or "ERROR"
Addressing	SL#I?	Get primary addresses (TX1, RX1)	"xxxx;yyyy"
Addressing	SL#I=xxxx	Set all addresses (RX1, RX2, TX1, TX2) to value xxxx [0000....ffff]	"OK" or "ERROR"
Addressing	SL#P?	Get primary transmit address (TX1) and primary receive address (RX1)	"xxxx;yyyy"
Addressing	SL#P=xxxx;yyyy	Set primary transmit address (TX1) to value xxxx and primary receive address (RX1) to value yyyy [0000....ffff]	"OK" or "ERROR"
Addressing	SL#Q?	Get TX address mode	"0" = TX address OFF "1" = TX address ON
Addressing	SL#Q=x	Set TX address ON/OFF. Values of x are: "0" = TX address OFF "1" = TX address ON	"OK" or "ERROR"
Addressing	SL#R?	Get primary receive address (RX1)	"yyyy"
Addressing	SL#R=xxxx	Set receive addresses (RX1, RX2) to value xxxx [0000....ffff]	"OK" or "ERROR"
Addressing	SL#S?	Get secondary transmit address (TX2) and secondary receive address (RX2)	"xxxx;yyyy"
Addressing	SL#S=xxxx;yyyy	Set secondary transmit address (TX2) to value xxxx and secondary receive address (RX2) to value yyyy [0000....ffff]	"OK" or "ERROR"
Addressing	SL#T?	Get primary transmit address (TX1)	"xxxx"
Addressing	SL#T=xxxx	Set transmit addresses (TX1, TX2) to value xxxx [0000....ffff]	"OK" or "ERROR"
Addressing	SL#W?	Get RX address mode	"0" = RX address OFF "1" = RX address ON
Addressing	SL#W=x	Set RX address ON/OFF. Values of x are: "0" = RX address OFF "1" = RX address ON	"OK" or "ERROR"
ChannelList	SL\$A=1	Go to channel list default channel	"OK" or "ERROR"
ChannelList	SL\$C?	Get number of channels in channel list	decimal number
ChannelList	SL\$C=nn	Set number of channels in channel list. nn = 0...40, 0 clears the whole list	"OK" or "ERROR"

ChannelList	SL\$D?	Get channel list default channel number	decimal number
ChannelList	SL\$D=n	Set channel list default channel, n is channel number	"OK" or "ERROR"
ChannelList	SL\$E=1	Search free channel Modem searches for next traffic-free channel. Listening time of traffic is about 2 seconds Modem shows next free channel by activating command again	"OK" followed by "channel n is free" Value of n is channel number of next free channel on channel list
ChannelList	SL\$F?	Get active channel number	decimal number
ChannelList	SL\$F=n	Set modem to channel number n in channel list	"OK" or "ERROR"
ChannelList	SL\$L?nn	Get channel info. Index nn=[0...(number of channels-1)]	Channel number, Frequency, Channel width, Tx Power For example: "CH 1, 430.150000 MHz, 25.0 kHz, 100 mW\0D"
ChannelList	SL\$L=laa,Nbbbbbb,Fccc.cccccc,Wdd.ddd,Peeee e<CR>	I = Index field aa = 0...39 //Future reservation 0...255 N = Channel number field bbbbbb = -32767...32767 F = Tx/Rx Frequency field ccc.cccccc = Tx/Rx Frequency in MHz (only numbers or "." allowed, "," is not allowed) W = Channel spacing/width field ddddd = 12.5, 20 or 25 (unit is kHz, trailing decimals are tolerated e.g. "25", "25.0", "25.00" and "25.000" are all valid) P = Transmitter power field eeeee = 0...35000 (modem rounds the value to the closest applicable) Note: 0 means "don't care" value for power. <CR> = Carriage return character	"OK" or "ERROR"
ChannelList	SL\$M?	Get status of channel list. 0 = Not in use, 1 = Channel list in use	"0" or "1"
ChannelList	SL\$M=n	Set status of channel list. 0 = Not in use, 1 = Channel list in use	"OK"
ChannelList	SL\$R?	Get listening time (seconds) of Search free channel function	decimal number
ChannelList	SL\$R=n	Set listening time (seconds) of Search free channel function	"OK" or "ERROR"
ChannelList	SL\$S=1	Set channel scanning mode When activated, modem scans	"OK" followed by channel/RSSI info For example: "OKCH 6 -

		channels one by one and saves RSSI readings to memory	122 dBm, CH 22 -121 dBm, CH 10003 -122 dBm, "
DataPort	SL%B?	Get serial data parameters	baud rate, character length, parity, number of stop bits (for example "38400, 8, N, 1")
DataPort	SL%B=a,b,c,d	Set serial data port parameters. a= "115200", "57600", "38400", "19200", "9600", "4800", "2400" or "1200" (defines baud rate) b="8" (defines character length) c= "N", "O" or "E" (defines parity) d= "1" (defines number of stop bits)	"OK" or "ERROR"
DataPort	SL%L?	Get pause length	Decimal number
DataPort	SL%L=n	Set pause length	"OK" or "ERROR"
Memory	SL**>	Save current settings as permanent settings	"OK" or "ERROR"
Memory	SL*R>	Restore settings to their factory set values	"OK" or "ERROR"
ModemInfo	SL!H?	Get radio HW info	"HW:nnnnn"
ModemInfo	SL!V?	Get modem "type"	Depending on variant, for example "M3-TR3"
ModemInfo	SL%1?	Get arbitrary data stored in memory location 1	If empty data is stored, response = "Undefined", otherwise data and carriage return
ModemInfo	SL%1="data"	Set arbitrary data (max 25 characters) in memory location 1	"OK" or "ERROR"
ModemInfo	SL%2?	Get arbitrary data stored in memory location 2	If empty data is stored, response = "Undefined", otherwise data and carriage return
ModemInfo	SL%2="data"	Set arbitrary data (max 25 characters) in memory location 2	"OK" or "ERROR"
ModemInfo	SL%3?	Get arbitrary data stored in memory location 3	If empty data is stored, response = "Undefined", otherwise data and carriage return
ModemInfo	SL%3="data"	Set arbitrary data (max 25 characters) in memory location 3	"OK" or "ERROR"
ModemInfo	SL%4?	Get arbitrary data stored in memory location 4	If empty data is stored, response = "Undefined", otherwise data and carriage return
ModemInfo	SL%4="data"	Set arbitrary data (max 25 characters) in memory location 4	"OK" or "ERROR"

ModemInfo	SL%D?	Get Modem Type	Depends on model, for example "M3-TR3"
ModemInfo	SL%H?	Get logic hardware version	Hardware info
ModemInfo	SL%S?	Get Serial Number	Serial number of radio modem
ModemInfo	SL%V?	Get firmware revision information	For example "V07.22.2.3.0.2"
RadioFreq	SL!D?	Get lower limit of frequency band 1	"nnn.nnnnn MHz"
RadioFreq	SL!U?	Get upper limit of frequency band 1	"nnn.nnnnn MHz"
RadioFreq	SL!W?	Get lower limit of frequency band 2	"nnn.nnnnn MHz"
RadioFreq	SL!Y?	Get upper limit of frequency band 2	"nnn.nnnnn MHz"
RadioFreq	SL&F?	Get active frequency	"TX nnn.nnnnn MHz, RX nnn.nnnnn MHz"
RadioFreq	SL&F=nnn.nnnn n	Set active frequency to nnn.nnnnn MHz	"OK" or "ERROR"
RadioFreq	SL&FR?	Get Rx frequency	"nnn.nnnnn MHz"
RadioFreq	SL&FR=nnn.nnn nn	Set Rx frequency to nnn.nnnnn MHz	"OK" or "ERROR"
RadioFreq	SL&FT?	Get Tx frequency	"nnn.nnnnn MHz"
RadioFreq	SL&FT=nnn.nnn nn	Set Tx frequency to nnn.nnnnn MHz	"OK" or "ERROR"
RadioFreq	SL&W?	Get channel spacing/channel width	"25.0 kHz", "20kHz", "12.5 kHz"
RadioFreq	SL&W=xxxx	Set channel spacing. Value of xxxx is: "1250" for 12,5 kHz "2000" for 20 kHz "2500" for 25 kHz Before using this command, make sure that active frequency matches new channel spacing	"OK" or "ERROR"
RadioFreq	SL&C?	Get center/reference frequency	"OK" or "ERROR"
RadioFreq	SL&C=nnn.nnnn n	Set center/reference frequency	"OK" or "ERROR"
RadioProperty	SL%F?	Get status of Error correction (FEC)	"0" = FEC OFF, "1" = FEC ON
RadioProperty	SL%F=x	Set Error correction (FEC). Value of x is: "1" Set FEC ON "0" Set FEC OFF	"OK" or "ERROR"
RadioProperty	SL%E?	Get status of Error check and Full CRC16 check modes	"0" Error check off "3" CRC16 Full

RadioProperty	SL%E=x	Set Error check and Full CRC16 check modes. Value of x is: "0" Error check off "3" CRC16 Full	"OK" or "ERROR"
RadioProperty	SL%R?	Get region code setting/status	0,0 = Default, 1,1 = US, 1,2 = US & Illegal radio setting combination (TX is disabled)
RadioProperty	SL@C?	Get Call sign settings	a, b, c followed by Carriage Return character, where: a=CallSignState (0=OFF, 1=ON) b=CallSignInterval (0..255) in minutes c=CallSignId (max 16 alphanumeric characters) For example: "1,5,MYMESSAGE" followed by Carriage Return character
RadioProperty	SL@C=a,b,c	Set Call Sign settings a=CallSignState (0=OFF, 1=ON) b=CallSignInterval (0..255) in minutes c=CallSignId (max 16 alphanumeric characters)	"OK" or "ERROR"
RadioProperty	SL@D?	Get Tx delay (ms)	For example "0 ms" or "50 ms"
RadioProperty	SL@D=n	Set Tx delay (ms), n is [0..65535]	"OK" or "ERROR"
RadioProperty	SL@E?	Get supported radio compatibility modes.	List of numbers, separated by commas, showing the supported modes: 0 = SATELLINE-3AS (Default. Original SATEL 4FSK, FEC ON or OFF) 1 = PacCrest-4FSK (FEC ON/ Scrambling ON) 2 = PacCrest-GMSK (FEC ON/ Scrambling ON) 3 = TrimTalk450s(P), GMSK. Rx fitted to PacCrest transmitters

			<p>4 = Trimtalk450s(T), GMSK. Rx fitted to Trimble transmitters</p> <p>5 = PacCrest-FST (FEC ON)</p> <p>6 = 2ASxE (ask availability)</p> <p>8 = SOUTH</p> <p>12 = Trimmark3</p> <p>16 = Pacific Crest FEC ON 4800bps 25kHz</p> <p>17 = Pacific Crest FEC OFF 4800bps 25kHz</p> <p>18 = Pacific Crest FEC OFF Scrambler OFF 4800bps 25kHz</p> <p>19 = Pacific Crest FEC ON Scrambler ON 4800bps 25kHz</p> <p>20 = SATEL-8FSK-1 (FEC OFF)</p> <p>21 = SATEL-8FSK-2 (FEC ON)</p> <p>22 = SATEL-16FSK-1 (FEC ON)</p> <p>23 = PacCrest-4FSK (FEC OFF/Scrambling ON)</p> <p>24 = PacCrest-GMSK (FEC OFF/Scrambling ON)</p> <p>25 = PacCrest-FST (FEC OFF)</p> <p>26 = PacCrest-4FSK (FEC OFF/Scrambling OFF)</p> <p>27 = PacCrest-GMSK (FEC OFF/Scrambling OFF)</p> <p>28 = PacCrest-4FSK (FEC ON/Scrambling OFF)</p> <p>29 = PacCrest-GMSK (FEC ON/Scrambling OFF)</p> <p>30 = Trimtalk v1, GMSK. 8/16kbps</p> <p>31 = Trimtalk 4800bps 25kHz</p> <p>34 = RTCM SC135 1 25 kHz FEC ON</p> <p>35 = RTCM SC135 2 12.5 kHz FEC ON</p> <p>36 = RTCM SC135 3 25 kHz FEC OFF</p>
--	--	--	--

			37 = RTCM SC135 4 12.5 kHz FEC OFF  For example: "0,1" indicates that the modem supports Satel 3AS and PacCrest 4FSK protocols.
RadioProperty	SL@F?	Get noise level of radio channel	"-xxx dBm"
RadioProperty	SL@M?	Get repeater function	"O" = Repeater OFF(character O) "R" = Repeater ON
RadioProperty	SL@M=x	Set repeater function. Values of x are: "O" = Repeater function OFF(character O) "R" = Repeater function ON	"OK" or "ERROR"
RadioProperty	SL@P?	Get transmitter output power	One of these values "10mW", "20mW", "50mW", "100mW", "200mW", "500mW", "1000 mW".
RadioProperty	SL@P=nnnnn	Set RF output power (mW) For example "SL@P=100" sets 100 mW transmitter output power. Range: 10, 20, 50, 100, 200, 500, 1000	"OK" / "ERROR"
RadioProperty	SL@R?	Get RSSI (Received Signal Strength Indication) of last received message (dBm)	"-nnn dBm", nnn is a decimal value of field strength between -10 dBm and -118 dBm. Value is available 7 s after reception.
Radio Property	SL@S?	Get radio compatibility mode	List of decimal numbers separated by commas, showing the supported modes. See list on lower left.
RadioProperty	SL@S=x	Set radio compatibility mode. Value of x is: 0 = SATELLINE-3AS (Default. Original SATEL 4FSK, FEC ON or OFF) 1 = PacCrest-4FSK (FEC ON/ Scrambling ON) 2 = PacCrest-GMSK (FEC ON/ Scrambling ON) 3 = TrimTalk450s(P), GMSK. Rx fitted to PacCrest transmitters 4 = Trimtalk450s(T), GMSK. Rx fitted to Trimble transmitters	decimal number

		<p>5 = PacCrest-FST (FEC ON)          6 = 2ASxE (ask availability)          8 = SOUTH          12 = Trimmark3          16 = Pacific Crest FEC ON 4800bps          25kHz          17 = Pacific Crest FEC OFF 4800bps          25kHz          18 = Pacific Crest FEC OFF Scrambler          OFF 4800bps 25kHz          19 = Pacific Crest FEC ON Scrambler          ON 4800bps 25kHz          20 = SATEL-8FSK-1 (FEC OFF)          21 = SATEL-8FSK-2 (FEC ON)          22 = SATEL-16FSK-1 (FEC ON)          23 = PacCrest-4FSK (FEC          OFF/Scrambling ON)          24 = PacCrest-GMSK (FEC          OFF/Scrambling ON)          25 = PacCrest-FST (FEC OFF)          26 = PacCrest-4FSK (FEC          OFF/Scrambling OFF)          27 = PacCrest-GMSK (FEC          OFF/Scrambling OFF)          28 = PacCrest-4FSK (FEC          ON/Scrambling OFF)          29 = PacCrest-GMSK (FEC          ON/Scrambling OFF)          30 = Trimtalk v1, GMSK. 8/16kbps          31 = Trimtalk 4800bps 25kHz          34 = RTCM SC135 1 25 kHz FEC ON          35 = RTCM SC135 2 12.5 kHz FEC ON          36 = RTCM SC135 3 25 kHz FEC OFF          37 = RTCM SC135 4 12.5 kHz FEC OFF</p>	
Radio Property	SL&P?	Get TX/RX priority.	1 = TX priority 2 = RX priority
Radio Property	SL&P=n	Set TX/RX priority. Value of n: 1 = TX priority 2 = RX priority	OK or ERROR
Reset	SL@X=n	Reset command. Values of n are: "9" Reset modem	"OK" or "ERROR", then modem resets required blocks.
Test	SL+P=xxxx	Get measured signal strength from remote modem i.e. SL "ping" Value of xxxx [0000...ffff] defines address of remote modem	"OK" followed by RSSI info from remote modem
Operational mode	SL++?	Get status of transmission control	"0" = Transmission enabled or "1" = Transmission disabled

Operational mode	SL+++	Disable radio transmission / reception	"OK" or "ERROR"
Operational mode	SL++0	Enable radio transmission / reception	"OK" or "ERROR"
Operational mode	SL%N=1	Set enabled radio states Tx/Rx	"OK" or "ERROR"
Operational mode	SL%N=0	Set enabled radio states Rx only	"OK" or "ERROR"
Operational mode	SL%N?	Get enabled radio states	0 (=Tx/Rx) or 1 (=Rx only)
Operation mode	SL+S=x	Activate sleep mode "1" turn the modem into a state where it will hold serial interface parts of the module on, wakeup will take approx. 30ms "5" Turns ON Power save mode. "6" Turns OFF Power save mode.	"OK" or "ERROR"
Operation mode	SL%Z=0	SL commands are OFF (working then only in the command mode) and CR/LF feature OFF	"OK" or "ERROR"
Operation mode	SL%Z=1	SL commands are always ON and CR/LF feature OFF	"OK" or "ERROR"
Operation mode	SL%Z=3	SL commands are always ON and CR/LF feature ON	"OK" or "ERROR"
Operation mode	SL%Z=4	SL commands are OFF (working then only in the command mode) and CR/LF feature ON	"OK" or "ERROR"
Operation mode	SL%Z?	Get SL command mode	Responds with a number accordingly

### 13.2.1 Encryption commands

Command	Effect and description of command	Response
SL%Y=n	Set radio encryption mode. Value of n: 0 = OFF 1 = AES128 2= AES256 (DRM option)	OK or ERROR
SL%Y?	Get Encryption mode.	Response: 0 = OFF 1= AES128 2= AES256 (DRM option)
SL%K?	Get radio encryption key hash. Response is to be used for the key match check	4 characters [0...9, A...F]
SL%A?	Get radio encryption key hash. Response is the same for SL%K? and SL%A?	4 characters [0...9, A...F]
SL%K=<Key>	Set radio encryption MAIN key, 32 characters (AES256 64 characters) [0...9, A...F]	OK or ERROR
SL%A=<Key>	Set radio encryption AUX key, 32 characters (AES256 64 characters) [0...9, A...F]	OK or ERROR